

PLASTIC DIVISION / METAL DIVISION



INDUSTRIAL VEHICLES EQUIPMENT

PLASTIC DIVISION

- 4 PARAFANGHI
- 6 CASSETTA CON SERBATOIO
- 8 CASSETTE PORTATTREZZI
- 17 SERBATOI PER ACQUA
- 18 PORTAESTINTORI
- 24 PORTA DOCUMENTI
- 26 CALZATOIE
- 27 PARAFANGHI TRATTORE AGRICOLO

PARAFANGHI

PARAJET



Finitura opaca



***Parajet con fissaggio assistito: marcatori di foratura per staffe registrabili in nylon

PARAJET			
CODICE	S x A x L x H	MATERIALE*	PESO kg
RPRE900230NO**	1400 x 900 x 230 x 415	PE	1,6
IPRE900280NO	1400 x 900 x 280 x 415	PP	1,3
IPRE780400NO	1180 x 780 x 400 x 370	PP	2
IPRE880400NO	1380 x 880 x 400 x 435	PP	2
IPRE880450NO	1380 x 880 x 450 x 435	PP	2,2
IPREA10510NO	1670 x 1010 x 510 x 540	PP	3,5
IPREB50550NO	1750 x 1150 x 550 x 540	PP	3,5
IPREB50600NO	1750 x 1150 x 600 x 555	PP	3,8
IPRED00435NO	1910 x 1300 x 435 x 590	PP	3,7
IPRED20435NO	2100 x 1320 x 435 x 660	PP	4
IPRED40650NO	2100 x 1340 x 650 x 670	PP	6
IPRED00700NO***	1900 x 1300 x 700 x 575	PP	5,4

*PP: polipropilene / stampaggio iniezione - PE: polietilene / stampaggio rotazionale
 **Finitura liscia
 ***Parajet con fissaggio assistito per staffe registrabili in nylon

PARAJET SOMMITÀ PIATTA			
CODICE	S x A x L x H	MATERIALE*	PESO kg
IPSE900280NO	1450 x 900 x 280 x 450	PP	1,5
IPSE910450NO	1470 x 910 x 450 x 450	PP	2,5
IPSEA00510NO	1725 x 1000 x 510 x 550	PP	3,8
RPSEA80550NO	1870 x 1080 x 550 x 555	PE	5,1

*PP: polipropilene / stampaggio iniezione - PE: polietilene / stampaggio rotazionale



NOTA: SERVIZIO PREMONTAGGIO ANTISPRAY/STAFFE A RICHIESTA



Normativa (EU) n. 109/2011

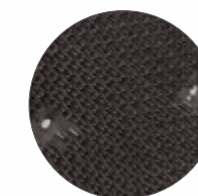

Fori fissaggio antispray

MEZZO PARAJET			
CODICE	S x L	MATERIALE*	PESO kg
IPME700450NO	700 x 450	PP	1,3
IPME700650NO	700 x 650	PP	1,9
IPME800450NO	800 x 450	PP	1,5
IPME800650NO	800 x 650	PP	2,2
IPMEA00450NO	1000 x 450	PP	1,8
IPMEA00650NO	1000 x 650	PP	2,8

*PP: polipropilene / stampaggio iniezione

ANTISPRAY NORMATIVA (EU) N. 109/2011			
CODICE	H x L	MATERIALE*	PESO kg
IASE750435NO	750 x 435	PP	1,2
IASE750500NO	750 x 500	PP	1,3
IASE750550NO	750 x 550	PP	1,4
IASE750600NO	750 x 600	PP	1,5
IASE750650NO	750 x 650	PP	1,7

*PP: polipropilene / stampaggio iniezione

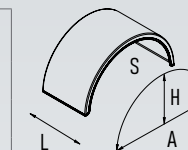

Legenda:
 S = Sviluppo (mm)
 A = Apertura (mm)
 L = Larghezza (mm)
 H = Altezza (mm)

CASSETTA CON SERBATOIO IDROBOX



LA GAMMA È CONFORME ALLA NORMATIVA **ECE R73.01** - DISPOSITIVO DI PROTEZIONE LATERALE

INSTALLAZIONE OBBLIGATORIA DI BARRE ORIZZONTALI DI SOSTEGNO SOTTO ALLA CASSETTA

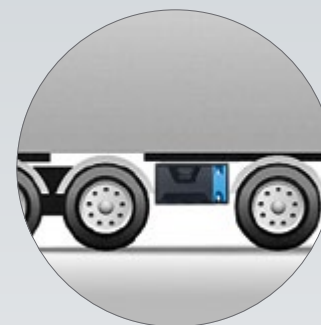

PLUS 1
Normativa ECE R73.01
(L'Omologazione è valida
solo con i supporti Co.Par.)



PLUS 2
Serbatoio acqua estraibile da 18 lt



PLUS 3
1 solo supporto per Cassetta + Serbatoio
risparmio del 50% sui costi
e tempi di installazione

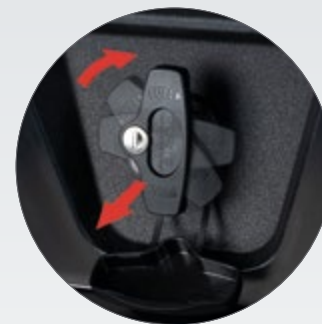

PLUS 4
Maniglia a trazione

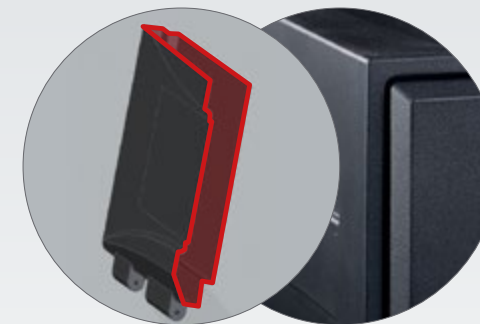

PLUS 5
Coperchio incassato a doppia parete



PLUS 6
Logo: etichetta plastificata rifrangente** / in rilievo



Rubinetto 3/4"



Tappo 2"



Saponiera

IDROBOX						
CODICE	ARTICOLO	L x P x H	MATERIALE*	PESO kg	CAPACITÀ lt	CAPACITÀ SERBATOIO lt
RFAED34000N0	IDROBOX 80	800 x 470 x 450	PE	12	90	18
RFAEC34000N0	IDROBOX 60	600 x 470 x 450	PE	10	55	18

*PE: polietilene / stampaggio rotazionale - Temperatura di resistenza: da +60°C a -45°C

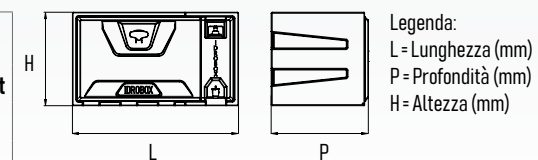

Legenda:
L = Lunghezza (mm)
P = Profondità (mm)
H = Altezza (mm)

SUPPORTI* & RICAMBI

CODICE	ARTICOLO
FSUMIDR080ZC	Supporto a "U" per IDROBOX 80
FSUMKT2X2GN7	Supporto a chassis per IDROBOX 80
FSUMKT4D2IN7	Supporto a "U" per IDROBOX 60
FSUMKT2X2IN7	Supporto a chassis per IDROBOX 60
RJSIDBOX00A0	Serbatoio acqua estraibile da 18 lt (solo corpo)
HACP060ACC	Rubinetto 3/4"
HACP030TAP	Tappo 2"
HACVDOS100B0	Saponiera (bianco)
HACSETBF0000	Etichetta plastificata rifrangente IDROBOX**

*Materiale: acciaio zincato a caldo

**Etichetta personalizzata su richiesta/Si applica un MOQ



Supporto a "U" per pianale



Supporto a chassis

CASSETTE PORTATTREZZI

MAGIC BOX



MAGIC BOX					
CODICE	ARTICOLO	L x P x H	MATERIALE*	PESO kg	CAPACITÀ lt
RNAEF34000N0	MAGIC BOX 120	1200 x 480 x 500	PE	17	231
RNAEF33000N0	MAGIC BOX 120 S	1200 x 480 x 400	PE	15,2	180,5
RNAEE34000N0	MAGIC BOX 100	1000 x 490 x 500	PE	12,8	190
RNAEE33000N0	MAGIC BOX 100 S	1000 x 490 x 400	PE	10,9	150,5
RNAED34000N0	MAGIC BOX 80	800 x 490 x 500	PE	10,3	151
RNAED33000N0	MAGIC BOX 80 S	800 x 490 x 400	PE	9,2	120
RNAEC45000N0	MAGIC BOX 70	700 x 600 x 500	PE	10	171,5
RNAEC44000N0	MAGIC BOX 70 S	700 x 350 x 350	PE	5,9	64
RNAEC34000N0	MAGIC BOX 60	600 x 470 x 450	PE	7,5	102
RNAEC33000N0	MAGIC BOX 60 S	600 x 470 x 400	PE	6,6	90
RNAEB13000N0	MAGIC BOX 50	500 x 370 x 400	PE	5,1	55
RNAEB22000N0	MAGIC BOX 50 S	500 x 450 x 300	PE	4,3	51,5
RNAEA12000N0	MAGIC BOX 40	400 x 370 x 350	PE	4	37,5

*PE: polietilene / stampaggio rotazionale - Temperatura di resistenza: da +60°C a -45°C

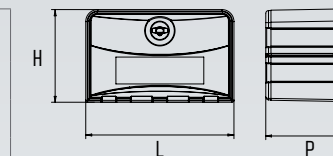

Legenda:
L = Lunghezza (mm)
P = Profondità (mm)
H = Altezza (mm)

SUPPORTI A PIANALE*		SUPPORTI A CHASSIS*	
CODICE	ARTICOLO	CODICE	ARTICOLO
FSUMKT4E2MN7	Supporto a "U" per MAGIC BOX 120	FSUMKT2X2MN7	Supporto a chassis per MAGIC BOX 120
FSUMKT4C2MN7	Supporto a "U" per MAGIC BOX 120 S	FSUMKT2X2MN7	Supporto a chassis per MAGIC BOX 120 S
FSUMKT4E2FN7	Supporto a "U" per MAGIC BOX 100	FSUMKT2X2FN7	Supporto a chassis per MAGIC BOX 100
FSUMKT4C2FN7	Supporto a "U" per MAGIC BOX 100 S	FSUMKT2X2FN7	Supporto a chassis per MAGIC BOX 100 S
FSUMKT4E2GN7	Supporto a "U" per MAGIC BOX 80	FSUMKT2X2GN7	Supporto a chassis per MAGIC BOX 80
FSUMKT4C2GN7	Supporto a "U" per MAGIC BOX 80 S	FSUMKT2X2GN7	Supporto a chassis per MAGIC BOX 80 S
FSUMKT4E2JN7	Supporto a "U" per MAGIC BOX 70	FSUMKT2X2JN7	Supporto a chassis per MAGIC BOX 70
FSUMKT4F2JN7	Supporto a "U" per MAGIC BOX 70 S	FSUMKT201JN7	Supporto a chassis per MAGIC BOX 70 S
FSUMKT4D2IN7	Supporto a "U" per MAGIC BOX 60	FSUMKT2X2IN7	Supporto a chassis per MAGIC BOX 60
FSUMKT4C2IN7	Supporto a "U" per MAGIC BOX 60 S	FSUMKT2X2IN7	Supporto a chassis per MAGIC BOX 60 S
FSUM4AXXN7	Barre laterali di supporto per MAGIC BOX 50	*Materiale: acciaio zincato a caldo	
FSUM4AXXN7	Barre laterali di supporto per MAGIC BOX 50 S		
FSUM4AXXN7	Barre laterali di supporto per MAGIC BOX 40		

*Materiale: acciaio zincato a caldo

RICAMBI	
CODICE	ARTICOLO
HACYMAGSOFNO	Maniglia a trazione

LA GAMMA È CONFORME ALLA NORMATIVA **ECE R73.01** - DISPOSITIVO DI PROTEZIONE LATERALE



PLUS 1
Normativa ECE R73.01
(L'Omologazione è valida
solo con i supporti Co.Par.)



PLUS 2
Maniglia a trazione

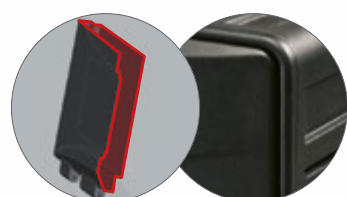

PLUS 3
Coperchio incassato a doppia parete



PLUS 4
Logo in rilievo

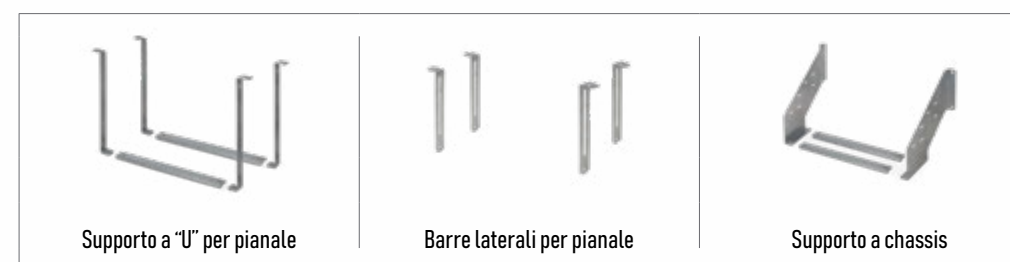

Supporto a "U" per pianale

Barre laterali per pianale

Supporto a chassis

CASSETTE PORTATTREZZI

NOVA BOX

EXTRA PLUS **IMPILABILE**

LA GAMMA È CONFORME ALLA NORMATIVA **ECE R73.01** - DISPOSITIVO DI PROTEZIONE LATERALE



PLUS 1
Normativa ECE R73.01
(L'Omologazione è valida
solo con i supporti Co.Par.)



PLUS 2
Maniglia a trazione

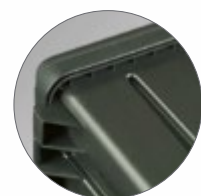

PLUS 3
Coperchio avvolgente



PLUS 4
Cerniera rinforzata



PLUS 5
Logo: in rilievo / etichetta

NOVA BOX					
CODICE	ARTICOLO	L x P x H	MATERIALE*	PESO kg	CAPACITÀ lt
ICBEE34000NO	NOVA BOX 100	1000 x 500 x 500	PP	9,4	160
ICBED34000NO	NOVA BOX 80	800 x 470 x 480	PP	7,5	124
ICBEC45000NO	NOVA BOX 64	640 x 490 x 530	PP	7	114
ICBEC32000NO	NOVA BOX 60	600 x 470 x 400	PP	5,2	72,5
ICBEB20000NO	NOVA BOX 50	500 x 400 x 350	PP	3,2	42
ICBEB19000NO	NOVA BOX 50 D	500 x 300 x 350	PP	3	30
ICBEA12000NO	NOVA BOX 40	400 x 300 x 350	PP	2,3	21

*PP: polipropilene / stampaggio iniezione - Temperatura di resistenza: da +60°C a -45°C

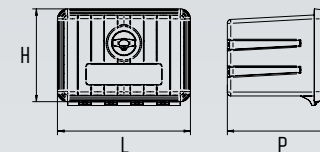

Legenda:
L = Lunghezza (mm)
P = Profondità (mm)
H = Altezza (mm)

SUPPORTI A PIANALE*	
CODICE	ARTICOLO
FSUMKT4D2NN7	Supporto a "U" per NOVA BOX 100
FSUMKT4D2HN7	Supporto a "U" per NOVA BOX 80
FSUMKT4E2KN7	Supporto a "U" per NOVA BOX 64
FSUMKT4B2LN7	Supporto a "U" per NOVA BOX 60
FSUM4AXXN7	Barre laterali di supporto per NOVA BOX 50
FSUM4AXXN7	Barre laterali di supporto per NOVA BOX 50 D
FSUM4AXXN7	Barre laterali di supporto per NOVA BOX 40

*Materiale: acciaio zincato a caldo

SUPPORTI A CHASSIS*	
CODICE	ARTICOLO
FSUMKT2X2NN7	Supporto a chassis per NOVA BOX 100
FSUMKT2X2HN7	Supporto a chassis per NOVA BOX 80
FSUMKT2X2KN7	Supporto a chassis per NOVA BOX 64
FSUMKT2X2LN7	Supporto a chassis per NOVA BOX 60

*Materiale: acciaio zincato a caldo

RICAMBI	
CODICE	ARTICOLO
HACYMAGSOFNO	Maniglia a trazione

SUPPORTO UNIVERSALE*	
CODICE	ARTICOLO
FSUMORNOVAN7	Supporto orizzontale per NOVA BOX 40 - 50 D - 50 - 60 - 64

*Materiale: acciaio zincato a caldo

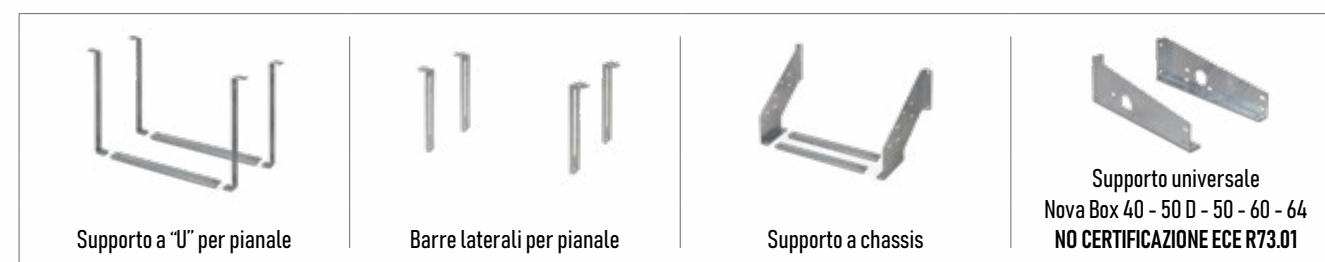

CASSETTE PORTATTREZZI

NOVA BOX 100 MULTI



EXTRA PLUS IMPILABILE



1. Luce LED



2. Cassetto (8 lt)



3. Paratia



4. Ripiano per coperchio



5. Kit catene sostegno coperchio

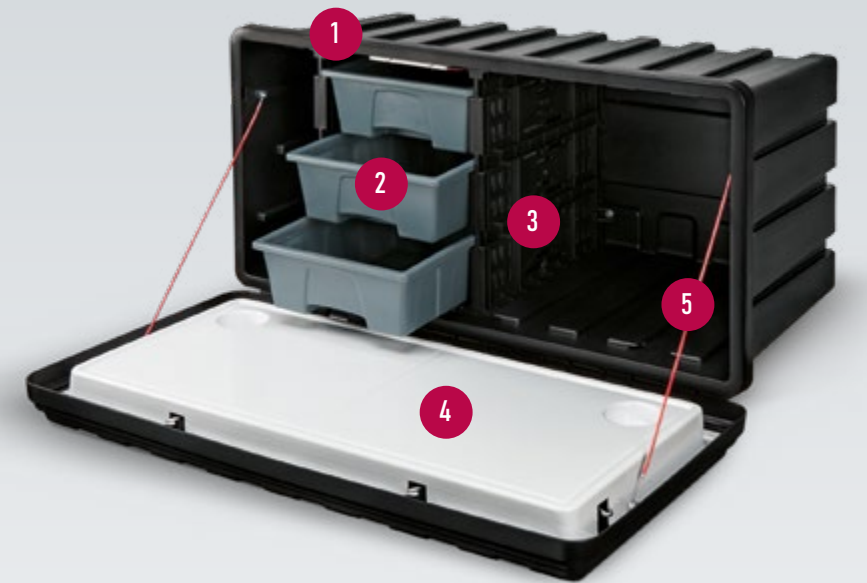

NOVA BOX 100					
CODICE	ARTICOLO	L x P x H	MATERIALE*	PESO kg	CAPACITÀ lt
ICBEE3400N0	NOVA BOX 100	1000 x 500 x 500	PP	9,4	160

*PP: polipropilene / stampaggio iniezione - Temperatura di resistenza: da +60°C a -45°C

SUPPORTI A PIANALE*	
CODICE	ARTICOLO
FSUMKT4D2NN7	Supporto a "U" per NOVA BOX 100

*Materiale: acciaio zincato a caldo

NOVA BOX 100 MULTI: ACCESSORI OPZIONALI & RICAMBI					
CODICE	ARTICOLO	MATERIALE	PESO kg	CAPACITÀ lt	
HACCKIT00100	Kit paratie (3 pz)	PP	2,7	-	
HACCKIT00300	Kit cassette (3 pz)	PE	2,1	8 x cassetto	
HACCKIT00200	Ripiano per coperchio	ABS	1,62	-	
HACCKIT00400	kit catene sostegno coperchio (2 pz)	INOX	0,05	-	
HACCKIT00700	Luce LED	-	0,05	-	

SUPPORTI A CHASSIS*	
CODICE	ARTICOLO
FSUMKT2X2NN7	Supporto a chassis per NOVA BOX 100

*Materiale: acciaio zincato a caldo

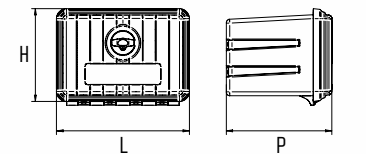

Legenda:
L = Lunghezza (mm)
P = Profondità (mm)
H = Altezza (mm)

PP = Polipropilene
PE = Polietilene
ABS = ABS

LA CASSETTA È CONFORME ALLA NORMATIVA **ECE R73.01** - DISPOSITIVO DI PROTEZIONE LATERALE

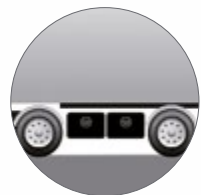

PLUS 1
Normativa ECE R73.01
(L'Omologazione è valida
solo con i supporti Co.Par.)



PLUS 2
Maniglia a trazione

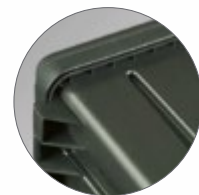

PLUS 3
Coperchio avvolgente



PLUS 4
Cerniera rinforzata



PLUS 5
Logo: in rilievo / etichetta

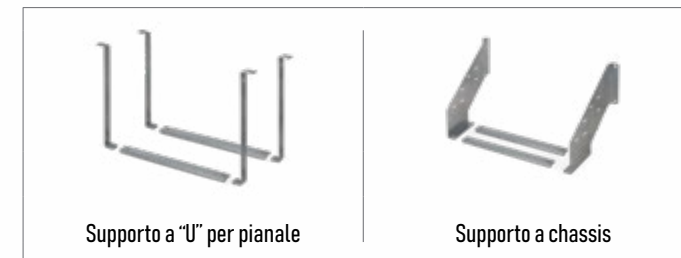

Supporto a "U" per pianale

Supporto a chassis

CASSETTE PORTATTREZZI

CASSETTA RTM 50X25X25



CASSETTE PORTATTREZZI

TRAILER BOX 63



ADATTA PER MONTAGGIO SU PARTE ANTERIORE RIMORCHIO

CASSETTA RTM 50X25X25					
CODICE	ARTICOLO	L x P x H	MATERIALE*	PESO kg	CAPACITÀ lt
RCAEB550000	CASSETTA RTM 50x25x25	500 x 250 x 250	PE	3	20

*PE: polietilene / stampaggio rotazionale - Temperatura di resistenza: da +60°C a -45°C

SUPPORTI* & RICAMBI				
CODICE	ARTICOLO	SISTEMA FISSAGGIO	BARRA LATERALE	
			H	S
FSUM4AXXN7	Supporto per CASSETTA RTM 50x25x25	BARRE LATERALI	315	5
HACXMM10DXCV	Maniglia			

*Materiale: acciaio zincato a caldo

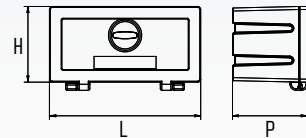

Legenda:
L = Lunghezza (mm)
P = Profondità (mm)
H = Altezza (mm)
S = Spessore (mm)

TRAILER BOX 63					
CODICE	ARTICOLO	L x P x H	MATERIALE*	PESO kg	CAPACITÀ lt
ICTRA630000	TRAILER BOX 63	630 x 321 x 355	PP	2,5	45

*PP: polipropilene / stampaggio iniezione - Temperatura di resistenza: da +60°C a -45°C

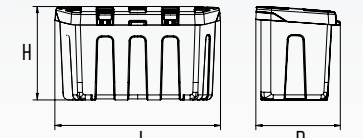

Legenda:
L = Lunghezza (mm)
P = Profondità (mm)
H = Altezza (mm)

ACCESSORIES & RICAMBI	
CODICE	ARTICOLO
IJTR3630000	Clip di chiusura ergonomica
HACTRAKITINO	Kit distanziatori (4 pz)



Maniglia



Logo

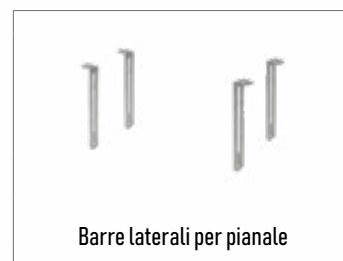

Barre laterali per pianale

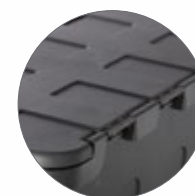

Coperchio avvolgente rinforzato



Clip chiusura ergonomica



Occhiello per lucchetto di sicurezza



Distanziatore (accessorio)



Logo

CASSETTE PORTATTREZZI

MINI BOX 35



SERBATOI PER ACQUA

IDRO 18 / 25 / 40



LA GAMMA È CONFORME ALLA NORMATIVA **ECE R73.01** - DISPOSITIVO DI PROTEZIONE LATERALE

MINI BOX 35					
CODICE	ARTICOLO	L x P x H	MATERIALE*	PESO kg	CAPACITÀ lt
ICAEA12000NO	MINI BOX 35	350 x 350 x 350	PP	2.2	26

*PP: polipropilene / stampaggio iniezione - Temperatura di resistenza: da +60°C a -45°C

SUPPORTI* & RICAMBI				
CODICE	ARTICOLO	SISTEMA FISSAGGIO	BARRA LATERALE	
			H	S
FSUM4AXXN7	Supporto per MINI BOX 35	BARRE LATERALI	315	5
HACYMINIOONO	Maniglia ergonomica			

*Materiale: acciaio zincato a caldo

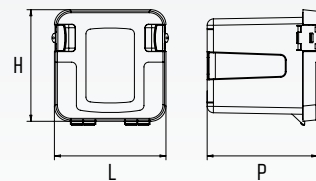

Legenda:
L = Lunghezza (mm)
P = Profondità (mm)
H = Altezza (mm)
S = Spessore (mm)

IDRO 18 / 25 / 40					
CODICE	ARTICOLO	L x P x H	MATERIALE*	PESO kg	CAPACITÀ lt
RSTIDRO18SNO	IDRO 18 (rubinetto + saponiera)	345 x 293 x 310	PE	1.9	18
RSTIDRO25SNO	IDRO 25 (rubinetto + saponiera)	300 x 495 x 303	PE	2.6	25
RSTIDRO40SNO	IDRO 40 (rubinetto + saponiera)	360 x 495 x 360	PE	3	40

*PE: polietilene / stampaggio rotazionale

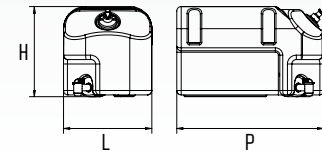

Legenda:
L = Larghezza (mm)
P = Profondità (mm)
L1 = Lunghezza
H (1 / 2 / 3) = Altezza (mm)
S = Spessore (mm)

SUPPORTI* & RICAMBI				
CODICE	ARTICOLO	L	H1/2/3	T
FSUMID1800ZC	Supporto per IDRO 18	130	248	3
FSUMORNOVAN7	Supporto per IDRO 25 / 40	455	158 / 82	3
HACPO60ACC	Rubinetto 3/4"			
HACPO30TAP	Tappo 2"			
HACVDOS100NO	Saponiera (nero)			

*Materiale: acciaio zincato a caldo

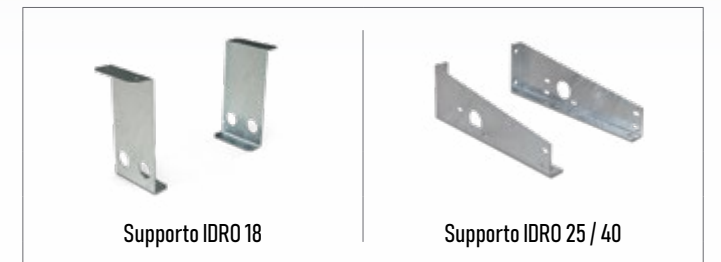

PLUS 1
Normativa ECE R73.01
(L'Omologazione è valida solo con i supporti Co.Par.)

PLUS 2
Coperchio avvolgente

Maniglia ergonomica

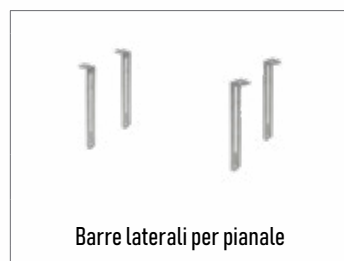

Barre laterali per pianale



Rubinetto laterale

Tubetto anti-schiacciamento

Tappo 2"

Rubinetto 3/4"

Saponiera

Logo

PORTAESTINTORI

UNICO 6



UNICO 6					
CODICE	ARTICOLO	L x P x H	MATERIALE*	PESO kg	Estintore kg
IESE600C01R0	UNICO 6	300 x 175 x 565	PP	2,6	6

*PP: polipropilene / stampaggio iniezione

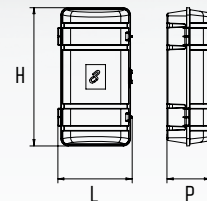

Legenda:
L = Larghezza (mm)
P = Profondità (mm)
H = Altezza (mm)

RICAMBI	
CODICE	ARTICOLO
FACCFLASCH04	Supporto in acciaio zincato
HACP075PEE	Cinghia di fissaggio in Nylon
HACPD4564N0	Gancio EPDM
HACVCOPO0200	Coppiglia di sicurezza



PLUS 1
Inserti PPEPDM



PLUS 2
Supporto in acciaio
zincato



PLUS 3
Gancio EPDM



Coppiglia di sicurezza



Logo

PORTAESTINTORI

UNICO 9-12



UNICO 9-12					
CODICE	ARTICOLO	L x P x H	MATERIALE*	PESO kg	Estintore kg
IESE912C01R0	UNICO 9-12	320 x 215 x 770	PP	4,3	9 / 12

*PP: polipropilene / stampaggio iniezione

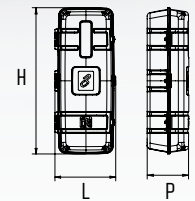

Legenda:
L = Larghezza (mm)
P = Profondità (mm)
H = Altezza (mm)

RICAMBI	
CODICE	ARTICOLO
FACCFLA12VNO	Supporto in acciaio verniciato nero
HACPEVE0A000	Fibbia in pu
HACPD4564N0	Gancio EPDM
HACVCOPO0200	Coppiglia di sicurezza
IDEM600F0000	Finestrella ispezione



Coperchio ermetico

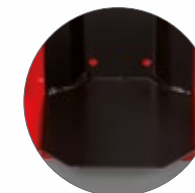

Supporto in acciaio
verniciato nero



Fibbia in PU
per rilascio rapido



Gancio EPDM



Finestrella ispezione

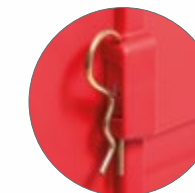

Coppiglia di sicurezza



Logo

PORTAESTINTORI

DEMON 6



DEMON 6					
CODICE	ARTICOLO	L x P x H	MATERIALE*	PESO kg	Estintore kg
IDEM602000NR	DEMON 6	314 x 240 x 607	PP	3	6

*PP: polipropilene / stampaggio iniezione

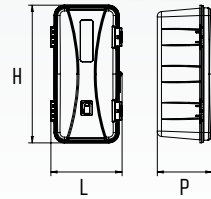

Legenda:
L = Larghezza (mm)
P = Profondità (mm)
H = Altezza (mm)

RICAMBI	
CODICE	ARTICOLO
HACP070PEE30	Cinghia di fissaggio in Nylon
HACVCOP00200	Coppiglia di sicurezza



Finestrella ispezione



Doppia fascetta di fissaggio in Nylon ultra resistente



Cinghia colorata a strappo di visibilità immediata per rilascio rapido



Coperchio avvolgente + guarnizione EPDM completamente ermetico

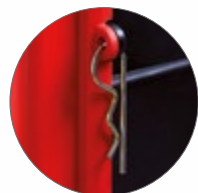

Coppiglia di sicurezza



Logo

PORTAESTINTORI

GRISÙ 6/9/12



GRISÙ 6/9/12					
CODICE	ARTICOLO	L x P x H	MATERIALE*	PESO kg	Estintore kg
RESEGRS690RN	GRISÙ 6-9 singolo	340 x 240 x 710	PE	4,6	6/9
RESEGRD690RN	GRISÙ 6-9 doppio	570 x 240 x 740	PE	7,5	6/9
RESEGRS912RN	GRISÙ 9-12 singolo	340 x 240 x 780	PE	5,9	9/12

*PE: polietilene / stampaggio rotazionale

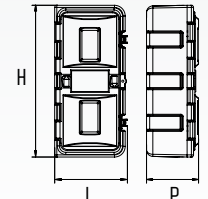

Legenda:
L = Larghezza (mm)
P = Profondità (mm)
H = Altezza (mm)

RICAMBI	
CODICE	ARTICOLO
HACP099PEE	Cinghia di fissaggio in Nylon

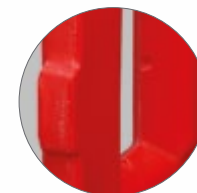

Doppia parete



Finestrella in plexiglas costampata



Cinghia di fissaggio

PORTAESTINTORE APERTURA SUPERIORE

ROCKET 6

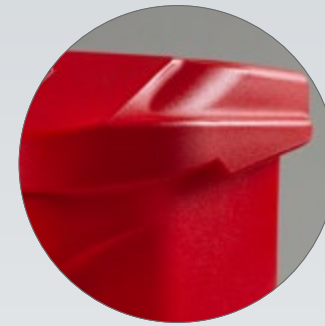

Coperchio avvolgente

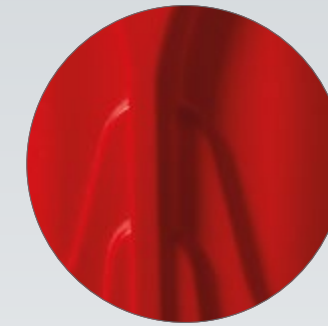

Nervature di rinforzo strutturale



Imbracatura di fissaggio



Etichetta adesiva rifrangente



Logo



Normativa ECE R73.01
(L'Omologazione è valida
solo con i supporti Co.Par.)

ROCKET 6					
CODICE	ARTICOLO	L x P x H	MATERIALE*	PESO kg	Estintore kg
RESER06000RO	ROCKET 6	265 x 290 x 655	PE	3,4	6

*PE: polietilene / stampaggio rotazionale

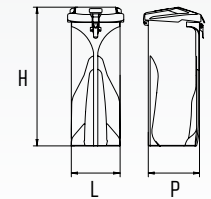

Legenda:
L = Larghezza (mm)
P = Profondità (mm)
H = Altezza (mm)

SUPPORTI*	
CODICE	ARTICOLO
FSUM4AXXN7	Supporto orizzontale
FSUMR06000ZC	Supporto regolabile

*Materiale: acciaio zincato a caldo



PORTA DOCUMENTI

DOCUBOX



DOCUBOX				
CODICE	ARTICOLO	L x P x H	MATERIALE*	PESO kg
IDOX10B000N0	DOCUBOX	283 x 61 x 363	PP	0,7
*PP: polipropilene / stampaggio iniezione				

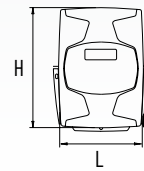

Legenda:
L = Larghezza (mm)
P = Profondità (mm)
H = Altezza (mm)

PORTA DOCUMENTI

POD



POD				
CODICE	ARTICOLO	L x P x H	MATERIALE*	PESO kg
RXCE00C10ANO	POD	280 x 60 x 350	PE	0,8
*PE: polietilene / stampaggio rotazionale				

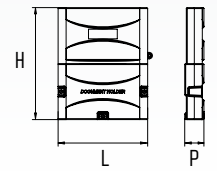

Legenda:
L = Larghezza (mm)
P = Profondità (mm)
H = Altezza (mm)

NOTA: ORDINABILE IN IMBALLI MULTIPLI DA 6 PEZZI



Lucchettabile
(lucchetto non incluso)



Laccio di sicurezza
in elastomero



Logo in rilievo
(su richiesta)

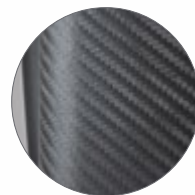

Finitura "Carbon look"

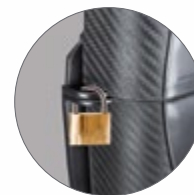

Lucchetto
NON INCLUSO



Chiusura ermetica



Coperchio rimovibile
con cavetto
acciaio INOX



Logo



Lucchetto
NON INCLUSO

CALZATOIE PLASTICA



LA GAMMA È OMOLOGATA A NORMA **DIN 76051**

CALZATOIE PLASTICA DIN 76051				
CODICE	ARTICOLO	L x L1 x H x R	MATERIALE*	PESO kg
HACPPACT1100	Calzatoia plastica NG53	200 x 470 x 230 x 460	PP	1,3
HACPPANG4600	Calzatoia plastica NG46	160 x 380 x 190 x 560	PP	0,8

*PP: polipropilene / stampaggio iniezione
 **Certificato ADR
 Made in Spain

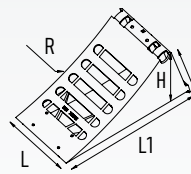

Legenda:
 L = Larghezza (mm)
 L1 = Lunghezza (mm)
 H = Altezza (mm)
 R = Raggio (mm)

SUPPORTI*	
CODICE	ARTICOLO
HACPPATG53N1	Supporto per 1 calzatoia NG53 o NG46
HACPPATG02N1	Supporto per 2 calzatoie NG53

*Materiale: zincato a caldo

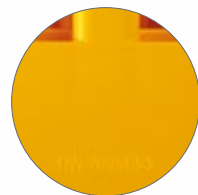

Omologazione
DIN 76051-53



Omologazione
DIN 76051-46

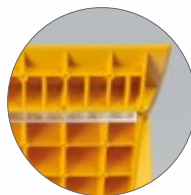

Lama antiscivolo
in acciaio
(solo su NG46)



Supporto per 1
calzatoia NG53 o NG46



Supporto per 2
calzatoie NG53

PARAFANGHI TRATTORE AGRICOLO



PARAFANGHI TRATTORE AGRICOLO			
CODICE	L x S x R	MATERIALE*	PESO kg
IPME81023SNO	230 x 810 x 540	PP	0,59
IPME89523SNO	230 x 895 x 540	PP	0,62
IPMEA00265NO	265 x 1000 x 615	PP	0,89
IPME95031SNO	315 x 950 x 680	PP	1,18
IPMEA0031SNO	315 x 1000 x 680	PP	1,24
IPMEB2731SNO	315 x 1127 x 680	PP	1,43
IPMEA7535SNO	355 x 1075 x 720	PP	1,57
IPMEC4535SNO	355 x 1245 x 720	PP	1,88
IPMEC4541SNO	410 x 1245 x 720	PP	2,10
IPMEE00520NO	520 x 1400 x 820	PP	3,04
IPMEF50520NO	520 x 1550 x 820	PP	3,39

*PP: polipropilene / stampaggio iniezione - Temperatura di resistenza: da +60°C a -45°C

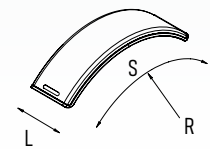

Legenda:
 L = Larghezza (mm)
 S = Sviluppo (mm)
 R = Raggio (mm)

METAL DIVISION

- 30 PARAFANGHI
- 40 KIT FISSAGGIO PARAFANGHI Ø 42
- 42 KIT FISSAGGIO PARAFANGHI Ø 54
- 44 MONTANTI
- 76 BARRE PARAINCASTRO
- 77 PROFILO FERMACARICO

PARAFANGHI

LAMIERA ZINCATA
CON BORDO IN PVC



ASSE SINGOLO	
SPESSORE LAMIERA: 0,8 MM	
CODICE	S x A x L
GPBZG650D40	2100 x 1340 x 650
GPBZG600D40	2100 x 1340 x 600
GPBZG450D40	2100 x 1340 x 450
GPBZP550C60	2000 x 1260 x 550
GPBZP650C00	1900 x 1200 x 650
GPBZP600C00	1900 x 1200 x 600
GPBZP550C00	1850 x 1200 x 550
GPBZP650B15	1800 x 1115 x 650
GPBZP600B15	1800 x 1115 x 600
GPBZP550B10	1750 x 1110 x 550
GPBZP500B20	1750 x 1120 x 500
GPBZP550A00	1650 x 1000 x 550
GPBZP500A00	1650 x 1000 x 500
GPBZP450A00	1500 x 1000 x 450
GPBZP425A00	1500 x 1000 x 425
GPBZP280A00	1500 x 1000 x 280
GPBZP240900	1300 x 900 x 240
GPBZP450880	1360 x 880 x 450
GPBZP400880	1360 x 880 x 400
GPBZP280880	1300 x 880 x 280
GPBZP220800	1300 x 800 x 220
GPBZG700D40A*	2100 x 1340 x 700

*Spessore: 1 mm

MULTI ASSE	
SPESSORE LAMIERA: 0,8 MM	
CODICE	S x A x L
GPIZG650Q00	4900 x 4100 x 650
GPIZG600Q00	4900 x 4100 x 600
GPIZG500Q00	4900 x 4100 x 500
GPIZG450Q00	4900 x 4100 x 450
GPIZG650N40	3500 x 2740 x 650
GPIZG600N40	3500 x 2740 x 600
GPIZG650M40	3400 x 2640 x 650
GPIZG600M40	3400 x 2640 x 600
GPIZG700N40A*	3500 x 2740 x 700

*Spessore: 1 mm

MEZZI	
SPESSORE LAMIERA: 0,8 MM	
CODICE	S x L
GPAZP650C00	1200 x 650
GPAZP650A00	1000 x 650
GPAZP600A00	1000 x 600
GPAZP500A00	1000 x 500
GPAZP650800	800 x 650
GPAZP600800	800 x 600
GPAZP500800	800 x 500
GPAZP650700	700 x 650
GPAZP600700	700 x 600
GPAZP500700	700 x 500
GPAZP600650	650 x 600
GPAZP600600	600 x 600

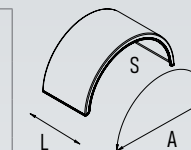

Legenda:
S = Sviluppo (mm)
A = Apertura (mm)
L = Larghezza (mm)

NOTA: PARAFANGHI FUORI MISURA DISPONIBILI SU RICHIESTA

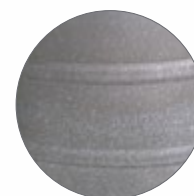

Lamiera zincata

PARAFANGHI

INOX AISI 304
CON BORDO IN PVC

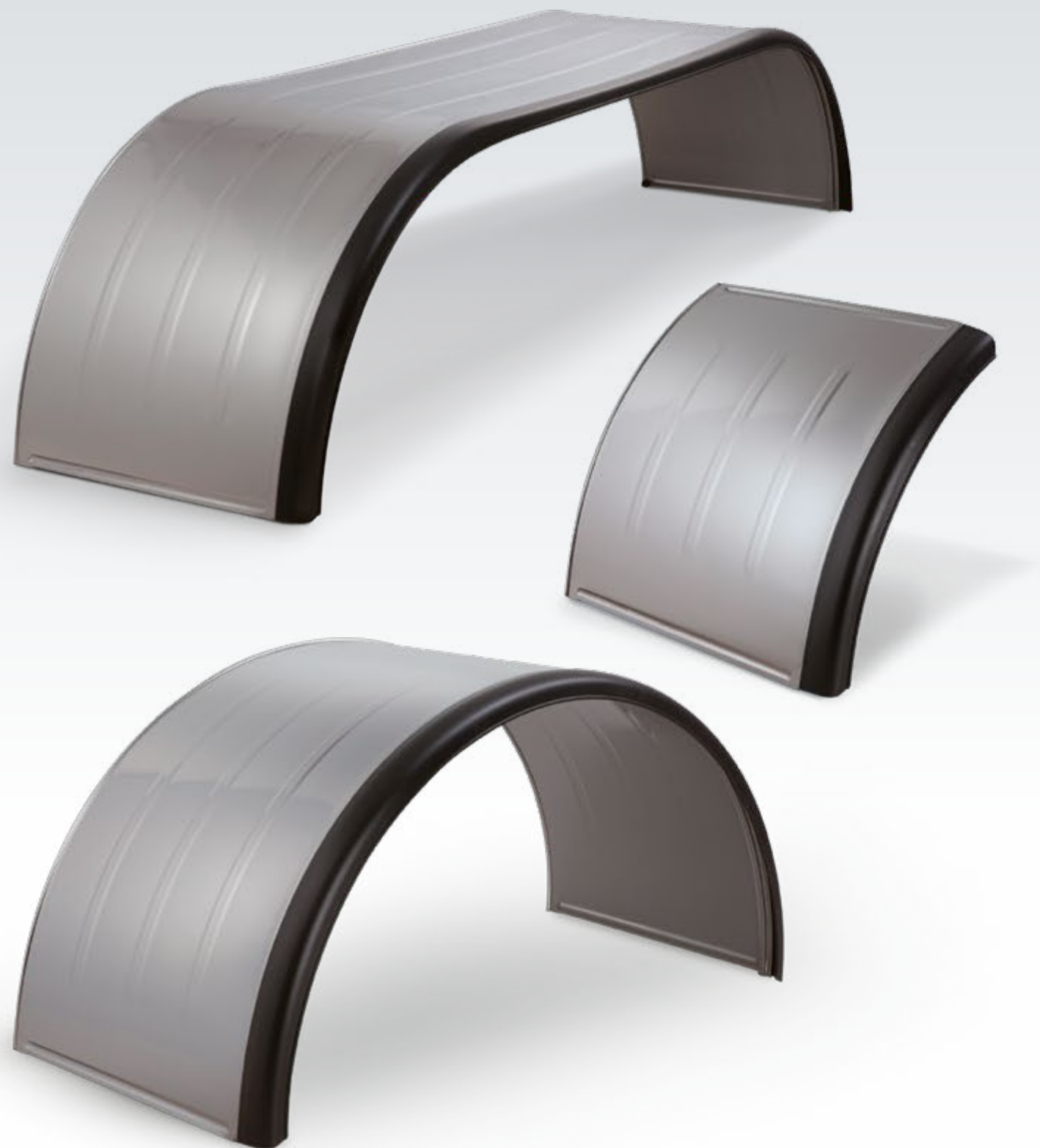

ASSE SINGOLO

SPESSORE LAMIERA: 0,8 MM

CODICE	S x A x L
GPBHG650D40	2100 x 1340 x 650
GPBHG600D40	2100 x 1340 x 600
GPBHG450D40	2100 x 1340 x 450
GPBHG550C60	2000 x 1260 x 550
GPBHG650C00	1900 x 1200 x 650
GPBHG600C00	1900 x 1200 x 600
GPBHG550C00	1850 x 1200 x 550
GPBHG650B15	1800 x 1115 x 650
GPBHG600B15	1800 x 1115 x 600
GPBHG550B10	1750 x 1110 x 550
GPBHG500B20	1750 x 1120 x 500
GPBHG550A00	1650 x 1000 x 550
GPBHG500A00	1650 x 1000 x 500
GPBHG450A00	1500 x 1000 x 450
GPBHG425A00	1500 x 1000 x 425
GPBHG450880	1360 x 880 x 450
GPBHG400880	1360 x 880 x 400
GPBHG280880	1300 x 880 x 280

MULTI ASSE

SPESSORE LAMIERA: 0,8 MM

CODICE	S x A x L
GPIHG650Q00	4900 x 4100 x 650
GPIHG500Q00	4900 x 4100 x 500
GPIHG450Q00	4900 x 4100 x 450
GPIHG650N40	3500 x 2740 x 650
GPIHG600N40	3500 x 2740 x 600

MEZZI

SPESSORE LAMIERA: 0,8 MM

CODICE	S x L
GPAHG650C00	1200 x 650
GPAHG650A00	1000 x 650
GPAHG500A00	1000 x 500
GPAHG650800	800 x 650
GPAHG600800	800 x 600
GPAHG500800	800 x 500
GPAHG650700	700 x 650
GPAHG600700	700 x 600
GPAHG500700	700 x 500
GPAHG650600	600 x 650
GPAHG600600	600 x 600

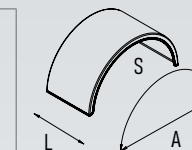

Legenda:
S = Sviluppo (mm)
A = Apertura (mm)
L = Larghezza (mm)

NOTA: PARAFANGHI FUORI MISURA DISPONIBILI SU RICHIESTA



Acciaio INOX AISI 304

PARAFANGHI

INOX "FIORE"
CON BORDO IN PVC



ASSE SINGOLO

SPESSORE LAMIERA: 0,8 MM

CODICE	S x A x L
GPBIG650D40	2100 x 1340 x 650
GPBIG600D40	2100 x 1340 x 600
GPBIG450D40	2100 x 1340 x 450
GPBIG550C60	2000 x 1260 x 550
GPBIG650C00	1900 x 1200 x 650
GPBIG600C00	1900 x 1200 x 600
GPBIG550C00	1850 x 1200 x 550
GPBIG650B15	1800 x 1115 x 650
GPBIG600B15	1800 x 1115 x 600
GPBIG550B10	1750 x 1110 x 550
GPBIG500B20	1750 x 1120 x 500
GPBIG550A00	1650 x 1000 x 550
GPBIG500A00	1650 x 1000 x 500
GPBIG450A00	1500 x 1000 x 450
GPBIG425A00	1500 x 1000 x 425
GPBIG450880	1360 x 880 x 450
GPBIG400880	1360 x 880 x 400
GPBIG280880	1300 x 880 x 280

MULTI ASSE

SPESSORE LAMIERA: 0,8 MM

CODICE	S x A x L
GPIIG650Q00	4900 x 4100 x 650
GPIIG500Q00	4900 x 4100 x 500
GPIIG450Q00	4900 x 4100 x 450
GPIIG650N40	3500 x 2740 x 650
GPIIG600N40	3500 x 2740 x 600
GPIIG650M40	3400 x 2640 x 650
GPIIG600M40	3400 x 2640 x 600

MEZZI

SPESSORE LAMIERA: 0,8 MM

CODICE	S x L
GPAIG650C00	1200 x 650
GPAIG650A00	1000 x 650
GPAIG500A00	1000 x 500
GPAIG650800	800 x 650
GPAIG600800	800 x 600
GPAIG500800	800 x 500
GPAIG650700	700 x 650
GPAIG600700	700 x 600
GPAIG500700	700 x 500
GPAIG650600	600 x 650
GPAIG600600	600 x 600

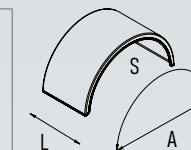

Legenda:
S = Sviluppo (mm)
A = Apertura (mm)
L = Larghezza (mm)

NOTA: PARAFANGHI FUORI MISURA DISPONIBILI SU RICHIESTA

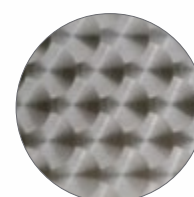

Acciaio INOX "FIORE"

PARAFANGHI

INOX "FIORE"

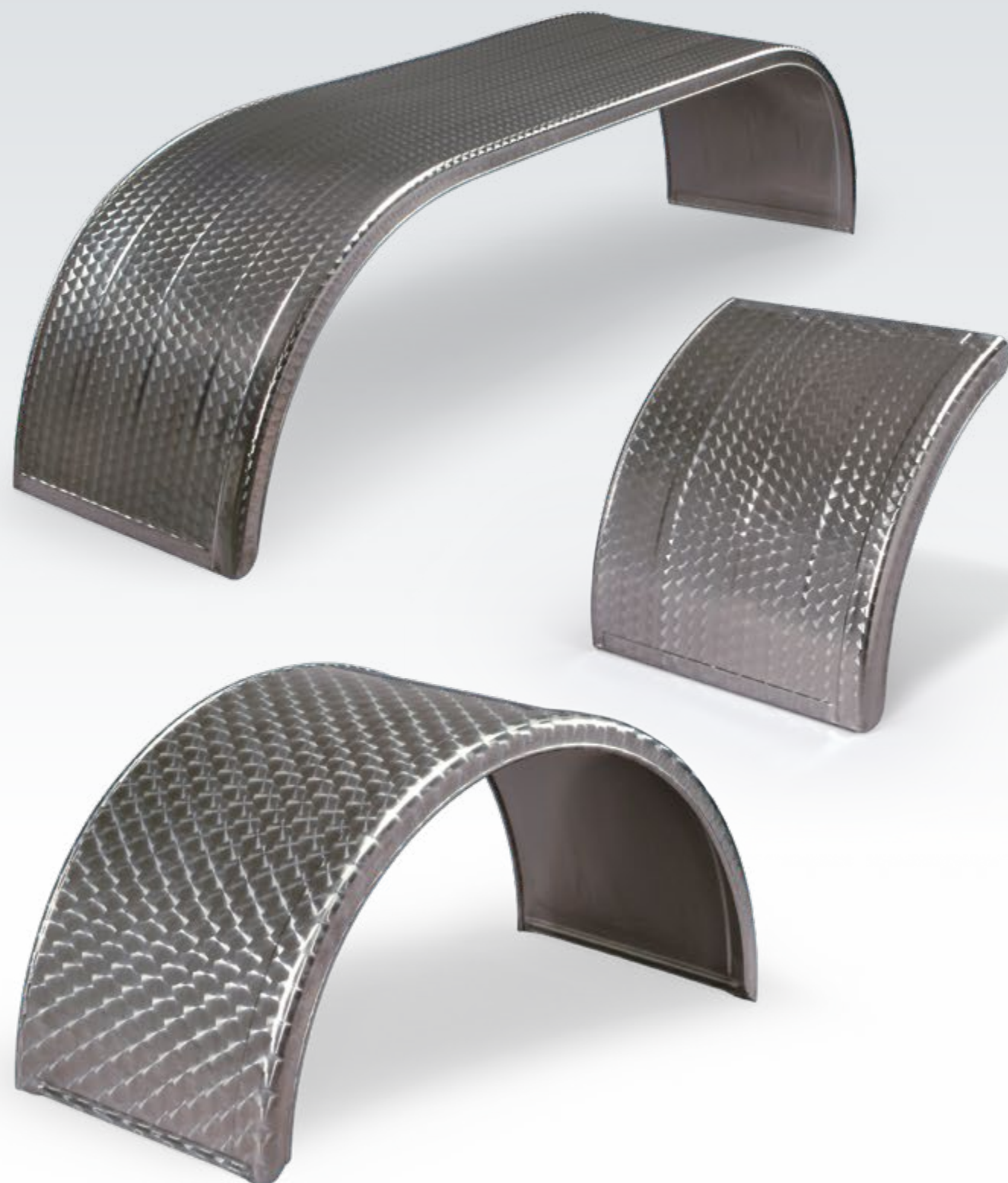

ASSE SINGOLO	
SPESSORE LAMIERA: 1 MM	
CODICE	S x A x L
FPBIG650D40	2100 x 1340 x 650
FPBIG450D40	2100 x 1340 x 450
FPBIG600C00	1900 x 1200 x 600
FPBIG550C00	1850 x 1200 x 550
FPBIG650B15	1800 x 1115 x 650
FPBIG600B15	1800 x 1115 x 600
FPBIG550B10	1750 x 1110 x 550
FPBIF550A00	1600 x 1000 x 550
FPBIF500A00	1600 x 1000 x 500
FPBIG450A00	1500 x 1000 x 450
FPBIG425A00	1500 x 1000 x 425
FPBIG450880	1360 x 880 x 450
FPBIG400880	1360 x 880 x 400
FPBIG280880	1360 x 880 x 280

MULTI ASSE	
SPESSORE LAMIERA: 1 MM	
CODICE	S x A x L
FPIIG650Q00	4900 x 4100 x 650
FPIIG500Q00	4900 x 4100 x 500
FPIIG450Q00	4900 x 4100 x 450
FPIIG650N40	3500 x 2740 x 650

MEZZI	
SPESSORE LAMIERA: 1 MM	
CODICE	S x L
FPAIG650C00	1200 x 650
FPAIG650A00	1000 x 650
FPAIG500A00	1000 x 500
FPAIG650800	800 x 650
FPAIG600800	800 x 600
FPAIG500800	800 x 500
FPAIG650700	700 x 650
FPAIG600700	700 x 600
FPAIG500700	700 x 500
FPAIG650600	600 x 650
FPAIG600600	600 x 600

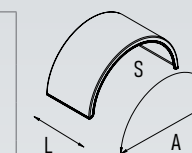

Legenda:
S = Sviluppo (mm)
A = Apertura (mm)
L = Larghezza (mm)

NOTA: PARAFANGHI FUORI MISURA DISPONIBILI SU RICHIESTA

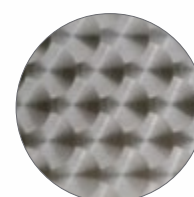

Acciaio INOX "FIORE"

PARAFANGHI SPIGOLATI

ACCIAIO INOX "FIORE" /
ALLUMINIO / ACCIAIO GREZZO

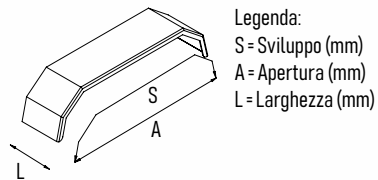
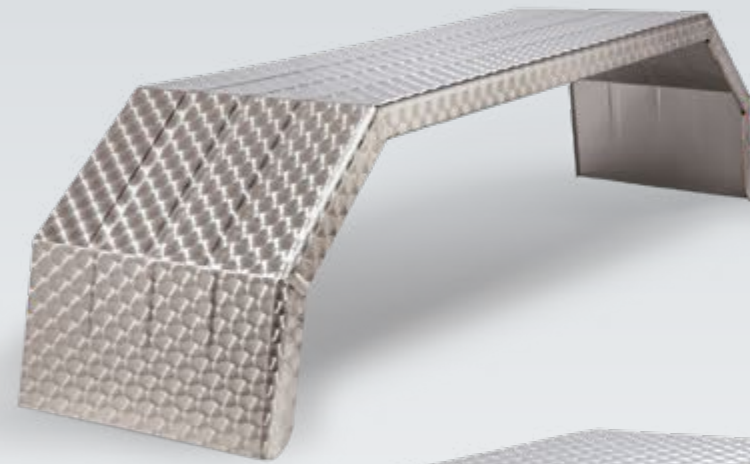

Legenda:
S = Sviluppo (mm)
A = Apertura (mm)
L = Larghezza (mm)

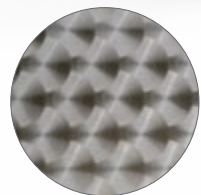

Acciaio INOX "FIORE"

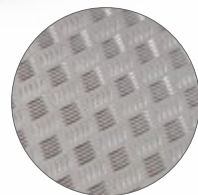

Alluminio

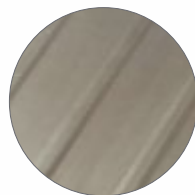

Acciaio grezzo

MULTI ASSE "FIORE"	
SPESSORE ACCIAIO INOX "FIORE": 1,5 MM	
CODICE	S x A x L
FPHI0171800	3500 x 2740 x 650

MULTI ASSE ALLUMINIO	
SPESSORE ALLUMINIO: 3 + 2 MM	
CODICE	S x A x L
FPIL3P227365	3500 x 2740 x 650

MULTI ASSE / ASSE SINGOLO ACCIAIO GREZZO	
SPESSORE ACCIAIO GREZZO: 1,8 MM	
CODICE	S x A x L
MULTI ASSE	
FPHA01718000	3500 x 2740 x 650
ASSE SINGOLO	
FPHN65022000	2200 x 1380 x 650
FPHA2204500	2200 x 1380 x 450

NOTA: PARAFANGHI FUORI MISURA
DISPONIBILI SU RICHIESTA

PARAFANGHI CARRELLO

LAMIERA ZINCATA
CON BORDO IN PVC



NOTA: PARAFANGHI FUORI MISURA
DISPONIBILI SU RICHIESTA

NOTA: ORDINABILE IN LOTTO MINIMO
DI 50 PEZZI PER CODICE

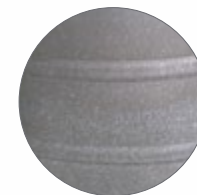

Lamiera zincata

ASSE SINGOLO	
SPESSORE LAMIERA: 1 MM	
CODICE	S x A x L
GPKZP240860	1380 x 860 x 240
GPKZP220860	1380 x 860 x 220
GPKZP240800	1285 x 800 x 240
GPKZP200750	1210 x 750 x 200
GPKZP200700	1130 x 700 x 200
GPKZP150700	1070 x 700 x 150
GPKZP190680	1060 x 680 x 190
GPKZP220640	970 x 640 x 220
GPKZP180640	970 x 640 x 180
GPKZP160620	970 x 620 x 160
GPKZP150580	930 x 580 x 150
GPKZP150560	910 x 560 x 150

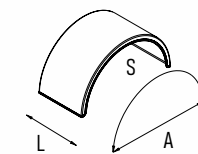

Legenda:
S = Sviluppo (mm)
A = Apertura (mm)
L = Larghezza (mm)

KIT FISSAGGIO PARAFANGHI Ø 42



Lamiera zincata

Acciaio INOX "FIORE"



Lamiera zincata

Acciaio verniciato

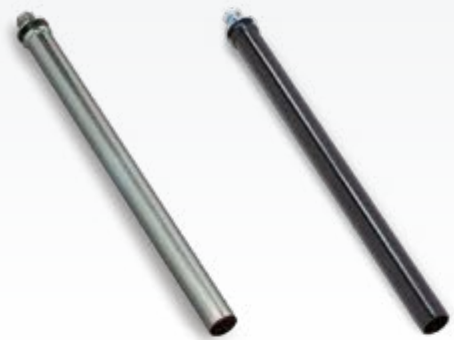

Lamiera zincata

Acciaio verniciato



Lamiera zincata

Acciaio verniciato

SUPPORTO REGISTRABILE (tubo + staffe)

CODICE	MATERIALE	L	S
FQAASUP042ZO	Lamiera zincata	600	2
FQAISUP04200	Acciaio INOX "FIORE"		

TUBO CON FLANGIA TRIANGOLARE A 3 FORI

CODICE	MATERIALE	L	S
FQAATB3060ZO		600	2.5
FQAATB3070ZO	Lamiera zincata	700	2.5
FQAATB3080ZO		800	2.5
FQAATB3060NO		600	2.5
FQAATB3070NO	Acciaio verniciato	700	2.5
FQAATB3080NO		800	2.5

TUBO CON TASSELLO M18

CODICE	MATERIALE	L	S
FQAATCT600ZO		600	2.5
FQAATCT700ZO	Lamiera zincata	700	2.5
FQAATCT800ZO		800	2.5
FQAATCT600NO		600	2.5
FQAATCT700NO	Acciaio verniciato	700	2.5
FQAATCT800NO		800	2.5

TUBO PIEGATO A "S" CON TASSELLO M18

CODICE	MATERIALE	L	S
FQAATMT075ZO	Lamiera zincata	800	2.5
FQAATMT075NO	Acciaio verniciato	800	2.5

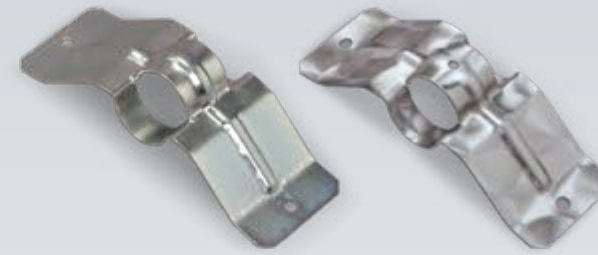

Lamiera zincata

Acciaio INOX "FIORE"



Lamiera zincata

Verniciato a polvere nera

Nylon



STAFFE

CODICE	MATERIALE
FQAASTA04200	Acciaio grezzo
FQAASTA042ZO	Lamiera zincata
FQAASTA042XX	Acciaio INOX "FIORE"

STAFFE REGISTRABILI

CODICE	MATERIALE	Ø
FQAASTRN42ZO	Lamiera zincata	42
FQAASTRN42NO	Verniciato a polvere nera	42
IQAYSTAO42R1	Nylon	42
IQAYSTAO40R1	Nylon	40
IQAYSTAO48R1	Nylon	48

ATTACCO SUPPORTO

CODICE	MATERIALE
FQAAATTO42ZO	Lamiera zincata

TAPPO PER SUPPORTO

CODICE	MATERIALE
IQAVTAP04200	PVC

KIT SUPPORTO PARACICLISTA - Ø 42

CODICE	ARTICOLO	MATERIALE	P	H	S
FQAAPRC042ZO	Supporto paraciclista	Lamiera zincata	600	470	2
FQAAATTO42ZO	Attacco per supporto	Lamiera zincata	-	-	-

Legenda:
L = Lunghezza (mm)
P = Profondità (mm)
H = Altezza (mm)
S = Spessore (mm)
Ø = Diametro (mm)

KIT FISSAGGIO PARAFANGHI Ø 54



Lamiera zincata

Acciaio INOX AISI 304

Acciaio INOX "FIORE"

SUPPORTO REGISTRABILE (tubo + staffe)

CODICE	MATERIALE	L	S
FQAASUP054Z0	Lamiera zincata		
FQAHSUP05400	Acciaio INOX AISI 304	740	2
FQAISUP05400	Acciaio INOX "FIORE"		



Lamiera zincata

TUBO

CODICE	MATERIALE	L	S
FQAATU7454Z0	Lamiera zincata	740	2



Lamiera zincata

Acciaio INOX AISI 304

TUBO PIEGATO 45°

CODICE	MATERIALE	L	S
FQAATU505400	Acciaio grezzo		2
FQAAT3505400	Acciaio grezzo		3
FQAATU5054Z0	Lamiera zincata	740	2
FQAAT35S4Z0	Lamiera zincata		3
FQAHTU455400	Acciaio INOX AISI 304		2



Lamiera zincata

Acciaio INOX AISI 304

SUPPORTO CENTRALE

CODICE	MATERIALE	L	S
FQAASUPCENZO	Lamiera zincata	740	2
FQAHSUPCEN00	Acciaio INOX AISI 304	740	2

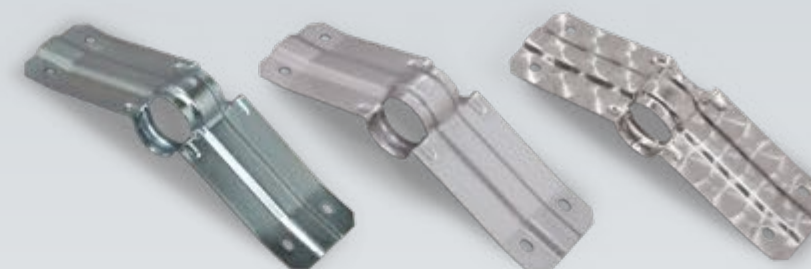

Lamiera zincata

Acciaio INOX AISI 304

Acciaio INOX "FIORE"

STAFFE

CODICE	MATERIALE
FQAASTA05400	Acciaio grezzo
FQAASTA054Z0	Lamiera zincata
FQAHSTA05400	Acciaio INOX AISI 304
FQAISTA05400	Acciaio INOX "FIORE"



STAFFA REGISTRABILE

CODICE	MATERIALE	Ø
IQAYSTA054R1	Nylon	54



ATTACCO SUPPORTO "MAMMUTH"

CODICE	MATERIALE
FQAAATM054Z0	Lamiera zincata



TAPPO

CODICE	MATERIALE
IQAVTAP05400	PVC



KIT SUPPORTO PARACICLISTA - Ø 54

CODICE	ARTICOLO	MATERIALE	P	H	S
FQAAPRC054Z0	Supporto paraciclista	Lamiera zincata	800	800	2
FQAAATM054Z0	Attacco per supporto "MAMMUTH"	Lamiera zincata	-	-	-

Legenda:
L = Lunghezza (mm)
P = Profondità (mm)
H = Altezza (mm)
S = Spessore (mm)
Ø = Diametro (mm)

MONTANTI

SPONDA FISSA



Tasca grezza a saldare

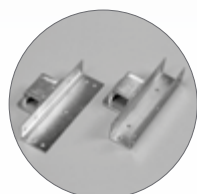

Tasca zincata laterale, posteriore

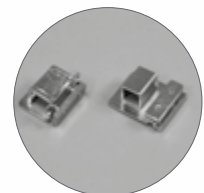

Tasca zincata regolabile: laterale, posteriore

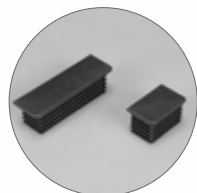

Tappo plastica: anteriore, centrale / posteriore



Ciabatta per montante [compresa]

SPONDA FISSA - cataforesi			
CODICE	ARTICOLO	SPESSORE SPONDA (mm)	H
FMAA400ADXN7	Anteriore destro	25	400
FMAA400ASXN7	Anteriore sinistro		
FMAA400CENN7	Centrale		
FMAA400PDXN7	Posteriore destro	25	500
FMAA400PSXN7	Posteriore sinistro		
FMAA500ADXN7	Anteriore destro		
FMAA500ASXN7	Anteriore sinistro	25	600
FMAA500CENN7	Centrale		
FMAA500PDXN7	Posteriore destro		
FMAA500PSXN7	Posteriore sinistro	25	800
FMAA600ADXN7	Anteriore destro		
FMAA600ASXN7	Anteriore sinistro		
FMAA600CENN7	Centrale	25	1000
FMAA600PDXN7	Posteriore destro		
FMAA600PSXN7	Posteriore sinistro		
FMAA800ADXN7	Anteriore destro	25	1100
FMAA800ASXN7	Anteriore sinistro		
FMAA800CENN7	Centrale		
FMAA800PDXN7	Posteriore destro	25	1200
FMAA800PSXN7	Posteriore sinistro		
FMAAA00ADXN7	Anteriore destro		
FMAAA00ASXN7	Anteriore sinistro	25	1000
FMAAA00CENN7	Centrale		
FMAAA00PDXN7	Posteriore destro		
FMAAA00PSXN7	Posteriore sinistro	25	1100
FMAAB00ADXN7	Anteriore destro		
FMAAB00ASXN7	Anteriore sinistro		
FMAAB00CENN7	Centrale	25	1200
FMAAB00PDXN7	Posteriore destro		
FMAAB00PSXN7	Posteriore sinistro		
FMAAC00ADXN7	Anteriore destro	25	1200
FMAAC00ASXN7	Anteriore sinistro		
FMAAC00CENN7	Centrale		
FMAAC00PDXN7	Posteriore destro	25	1200
FMAAC00PSXN7	Posteriore sinistro		

ACCESSORI & RICAMBI	
CODICE	ARTICOLO
FCSMTASSAL00	Tasca grezza a saldare
FCPMTASLATZ0	Tasca zincata laterale
FCPMTASPOSZ0	Tasca zincata posteriore
FCPMTASRLAZ0	Tasca zincata regolabile laterale completa
FCPMTASRP0Z0	Tasca zincata regolabile posteriore completa
IQAVTAPMANTO	Tappo plastica anteriore
IQAVTAPMCNPT	Tappo plastica centrale / posteriore
FCPMCIASFO00	Ciabatta per montante [compresa]

TERMINALI - zincati		
CODICE	ARTICOLO	H
FOAC400LDXZ0	Laterale destro	400
FOAC400LSXZ0	Laterale sinistro	
FOAC400PDXZ0	Posteriore destro	
FOAC400PSXZ0	Posteriore sinistro	
FOAC500LDXZ0	Laterale destro	500
FOAC500LSXZ0	Laterale sinistro	
FOAC500PDXZ0	Posteriore destro	
FOAC500PSXZ0	Posteriore sinistro	
FOAC600LDXZ0	Laterale destro	600
FOAC600LSXZ0	Laterale sinistro	
FOAC600PDXZ0	Posteriore destro	
FOAC600PSXZ0	Posteriore sinistro	
FOAC800LDXZ0	Laterale destro	800
FOAC800LSXZ0	Laterale sinistro	
FOAC800PDXZ0	Posteriore destro	
FOAC800PSXZ0	Posteriore sinistro	
FOACA00LDXZ0	Laterale destro	1000
FOACA00LSXZ0	Laterale sinistro	
FOACA00PDXZ0	Posteriore destro	
FOACA00PSXZ0	Posteriore sinistro	
FOAC800LDXZ0	Laterale destro	1100
FOAC800LSXZ0	Laterale sinistro	
FOAC800PDXZ0	Posteriore destro	
FOAC800PSXZ0	Posteriore sinistro	
FOACC00LDXZ0	Laterale destro	1200
FOACC00LSXZ0	Laterale sinistro	
FOACC00PDXZ0	Posteriore destro	
FOACC00PSXZ0	Posteriore sinistro	

TABELLA			
MOD. H	A	B	C
400	400	345	55
500	500	345	155
600	600	445	155
800	800	582	218
1000	1000	448	399
1100	1100	448	499
1200	1200	448	599

Legenda:

H = Altezza (mm)

MOD. H = Modello - Altezza (mm)

A/B/C = (mm)

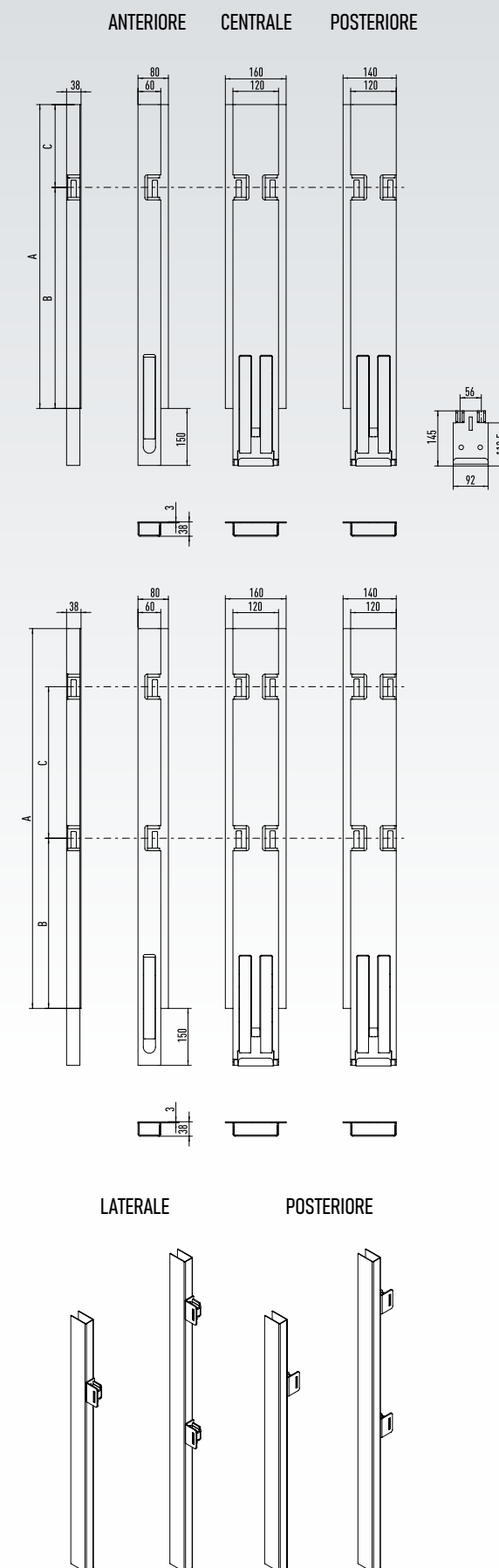

MONTANTI RIBALTABILI



RIBALTABILI - cataforesi			
CODICE	ARTICOLO	SPESSORE SPONDA (mm)	H
FMCB400ADXN7	Anteriore dx_Largo 80	25	400
FMCB400ASXN7	Anteriore sx_Largo 80		
FMCA400CENN7	Centrale		
FMCA400PDXN7	Posteriore destro		
FMCA400PSXN7	Posteriore sinistro		
FMCB500ADXN7	Anteriore dx_Largo 80		
FMCB500ASXN7	Anteriore sx_Largo 80		
FMCA500CENN7	Centrale		
FMCA500PDXN7	Posteriore destro		
FMCA500PSXN7	Posteriore sinistro		
FMCB600ADXN7	Anteriore dx_Largo 80	25	600
FMCB600ASXN7	Anteriore sx_Largo 80		
FMCA600CENN7	Centrale		
FMCA600PDXN7	Posteriore destro		
FMCA600PSXN7	Posteriore sinistro		
FMCB800ADXN7	Anteriore dx_Largo 80		
FMCB800ASXN7	Anteriore sx_Largo 80		
FMCA800CENN7	Centrale		
FMCA800PDXN7	Posteriore destro		
FMCA800PSXN7	Posteriore sinistro		
FMCBA00ADXN7	Anteriore dx_Largo 80	25	1000
FMCBA00ASXN7	Anteriore sx_Largo 80		
FMCAA00CENN7	Centrale		
FMCAA00PDXN7	Posteriore destro		
FMCAA00PSXN7	Posteriore sinistro		
FMCBB00ADXN7	Anteriore dx_Largo 80		
FMCBB00ASXN7	Anteriore sx_Largo 80		
FMCA800CENN7	Centrale		
FMCA800PDXN7	Posteriore destro		
FMCA800PSXN7	Posteriore sinistro		
FMCBC00ADXN7	Anteriore dx_Largo 80	25	1200
FMCBC00ASXN7	Anteriore sx_Largo 80		
FMCA00CENN7	Centrale		
FMCA00PDXN7	Posteriore destro		
FMCA00PSXN7	Posteriore sinistro		

ACCESSORI & RICAMBI	
CODICE	ARTICOLO
FCPMCIASF000	Ciabatta per montante [compresa]



Ciabatta per montante
[compresa]

TERMINALI - zincati



CODICE	ARTICOLO	H
FOBC400RIBZO	Laterale / Posteriore	400
FOBC500RIBZO	Laterale / Posteriore	500
FOBC600RIBZO	Laterale / Posteriore	600
FOBC800RIBZO	Laterale / Posteriore	800
FOBCA00LDXZO	Laterale destro	1000
FOBCA00LSXZO	Laterale sinistro	
FOBCA00PDXZO	Posteriore destro	
FOBCA00PSXZO	Posteriore sinistro	
FOBCB00LDXZO	Laterale destro	1100
FOBCB00LSXZO	Laterale sinistro	
FOBCB00PDXZO	Posteriore destro	
FOBCB00PSXZO	Posteriore sinistro	
FOBCC00LDXZO	Laterale destro	1200
FOBCC00LSXZO	Laterale sinistro	
FOBCC00PDXZO	Posteriore destro	
FOBCC00PSXZO	Posteriore sinistro	

TABELLA

MOD. H	A	B	C
400	400	378	-
500	500	478	-
600	600	578	-
800	800	778	-
1000	1000	448	530
1100	1100	448	630
1200	1200	448	730

Legenda:
H = Altezza (mm)

MOD. H = Modello - Altezza (mm)
A/B/C = (mm)

ANTERIORE CENTRALE POSTERIORE

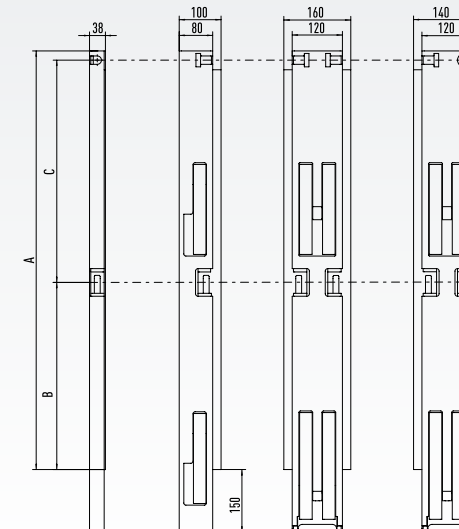
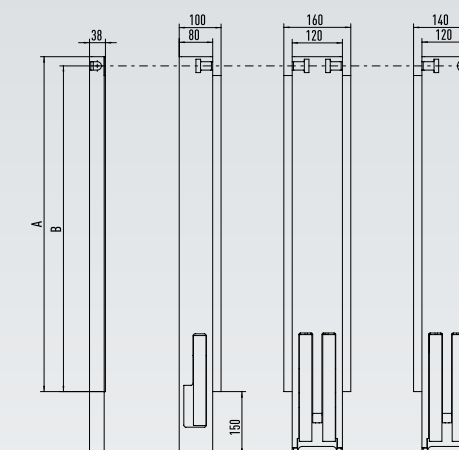

LATERALE / POSTERIORE LATERALE POSTERIORE

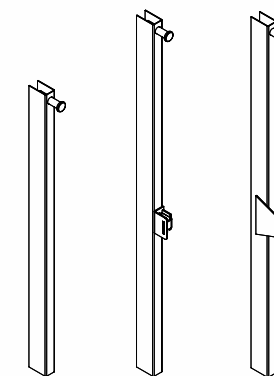

MONTANTI

RIBALTABILI INNESTO LEGGERO DOPPIA ALTEZZA



RIBALTABILI INNESTO LEGGERO DOPPIA ALTEZZA - cataforesi			
CODICE	ARTICOLO	SPESSORE SPONDA (mm)	H
FMEAL50PDXN7	Posteriore destro	25	400 / 500
FMEAL50PSXN7	Posteriore sinistro		

RIBALTABILI INNESTO LEGGERO DOPPIA ALTEZZA DRITTO - cataforesi			
CODICE	ARTICOLO	SPESSORE SPONDA (mm)	H
FMEAM45PDXN7	Posteriore destro	25	400 / 500
FMEAM45PSXN7	Posteriore sinistro		

ACCESSORI & RICAMBI	
CODICE	ARTICOLO
HACHL12FEM00	Innesto leggero forgiato femmina_Largo 120 mm

TERMINALI - zincati		
CODICE	ARTICOLO	H
FOBC400RIBZO	Laterale / Posteriore	400
FOBC405RIBZO	Laterale / Posteriore	400 / 500

Legenda:
H = Altezza (mm)

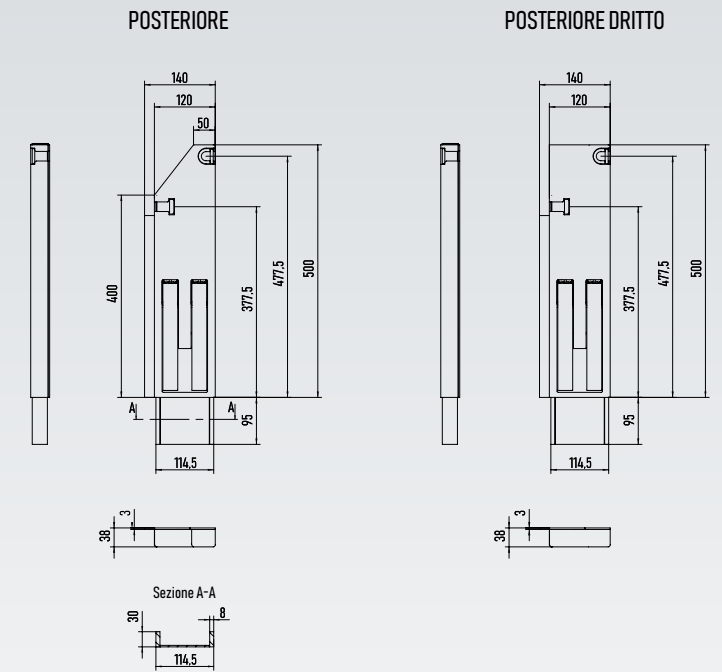

LATERALE / POSTERIORE

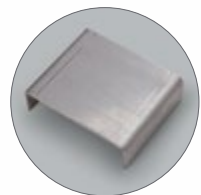
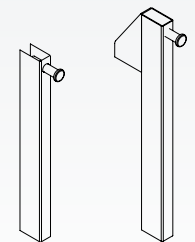

Innesto leggero forgiato
femmina_Largo 120 mm

MONTANTI

RIBALTABILI TASCA A CUNEO



RIBALTABILI TASCA A CUNEO - cataforesi			
CODICE	ARTICOLO	SPESSORE SPONDA (mm)	H
FMDB500ADXN7	Anteriore dx_Largo 80	25	500
FMDB500ASXN7	Anteriore sx_Largo 80		
FMDA500CENN7	Centrale		
FMDA500PDXN7	Posteriore destro		
FMDA500PSXN7	Posteriore sinistro		
FMDB600ADXN7	Anteriore dx_Largo 80		
FMDB600ASXN7	Anteriore sx_Largo 80		
FMDA600CENN7	Centrale		
FMDA600PDXN7	Posteriore destro		
FMDA600PSXN7	Posteriore sinistro		
FMDB700ADXN7	Anteriore dx_Largo 80	25	700
FMDB700ASXN7	Anteriore sx_Largo 80		
FMDA700CENN7	Centrale		
FMDA700PDXN7	Posteriore destro		
FMDA700PSXN7	Posteriore sinistro		
FMDB800ADXN7	Anteriore dx_Largo 80		
FMDB800ASXN7	Anteriore sx_Largo 80		
FMDA800CENN7	Centrale		
FMDA800PDXN7	Posteriore destro		
FMDA800PSXN7	Posteriore sinistro		
FMDBA00ADXN7	Anteriore dx_Largo 80	25	1000
FMDBA00ASXN7	Anteriore sx_Largo 80		
FMDAA00CENN7	Centrale		
FMDAA00PDXN7	Posteriore destro		
FMDAA00PSXN7	Posteriore sinistro		
FMDBB00ADXN7	Anteriore dx_Largo 80		
FMDBB00ASXN7	Anteriore sx_Largo 80		
FMDAB00CENN7	Centrale		
FMDAB00PDXN7	Posteriore destro		
FMDAB00PSXN7	Posteriore sinistro		
FMDBC00ADXN7	Anteriore dx_Largo 80	25	1200
FMDBC00ASXN7	Anteriore sx_Largo 80		
FMDAC00CENN7	Centrale		
FMDAC00PDXN7	Posteriore destro		
FMDAC00PSXN7	Posteriore sinistro		

ACCESSORI & RICAMBI	
CODICE	ARTICOLO
HACHFORMAS00	Innesto forgiato maschio
HACHFORFEM00	Innesto forgiato femmina



Innesto forgiato maschio

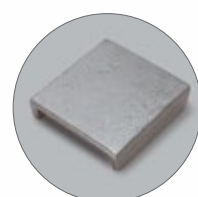

Innesto forgiato femmina

TERMINALI - zincati



CODICE	ARTICOLO	H
FOBC500RIBZO	Laterale / Posteriore	500
FOBC600RIBZO	Laterale / Posteriore	600
FOBC700RIBZO	Laterale / Posteriore	700
FOBC800RIBZO	Laterale / Posteriore	800
FOCCA00LDXZO	Laterale destro	1000
FOCCA00LSXZO	Laterale sinistro	
FOCCA00PDXZO	Posteriore destro	
FOCCA00PSXZO	Posteriore sinistro	
FOCCB00LDXZO	Laterale destro	1100
FOCCB00LSXZO	Laterale sinistro	
FOCCB00PDXZO	Posteriore destro	
FOCCB00PSXZO	Posteriore sinistro	
FOCCC00LDXZO	Laterale destro	1200
FOCCC00LSXZO	Laterale sinistro	
FOCCC00PDXZO	Posteriore destro	
FOCCC00PSXZO	Posteriore sinistro	

TABELLA

MOD. H	A	B	C
500	500	478	-
600	600	578	-
700	700	678	-
800	800	778	-
1000	1000	457	521
1100	1100	457	621
1200	1200	557	621

Legenda:
H = Altezza (mm)

MOD. H = Modello - Altezza (mm)
A/B/C = (mm)

ANTERIORE CENTRALE POSTERIORE

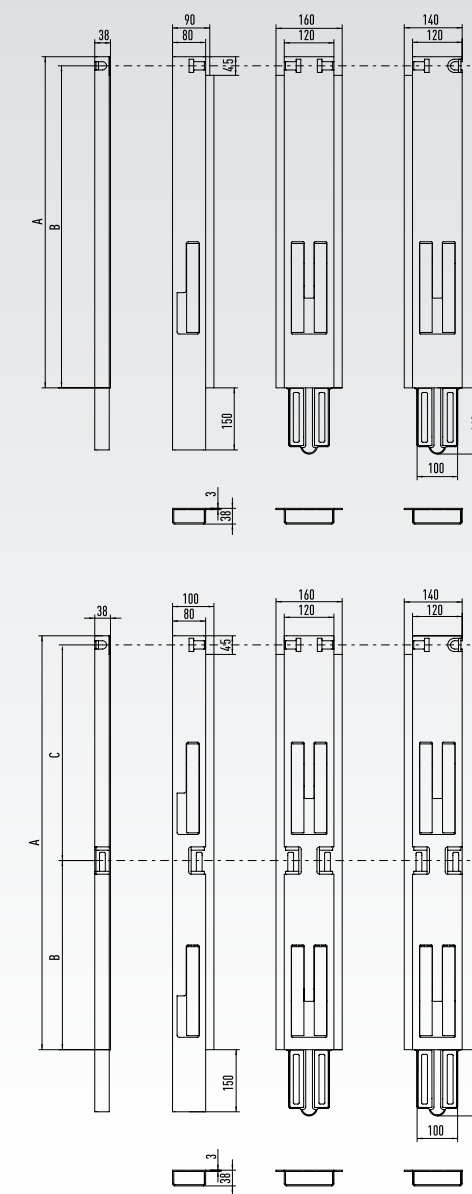

LATERALE / POSTERIORE LATERALE POSTERIORE

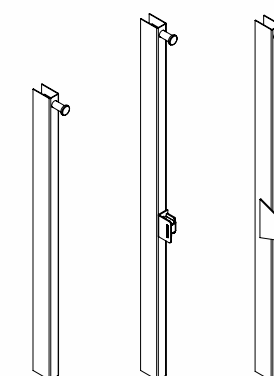

MONTANTI

RIBALTABILI TASCA A CUNEO DOPPIA ALTEZZA



RIBALTABILI TASCA A CUNEO DOPPIA ALTEZZA - cataforesi			
CODICE	ARTICOLO	SPESSORE SPONDA (mm)	H
FMDA550PDXN7	Posteriore destro	25	500 / 600
FMDA550PSXN7	Posteriore sinistro		
FMDA650PDXN7	Posteriore destro	25	600 / 700
FMDA650PSXN7	Posteriore sinistro		

RIBALTABILI TASCA A CUNEO DOPPIA ALTEZZA DRITTO - cataforesi			
CODICE	ARTICOLO	SPESSORE SPONDA (mm)	H
FMDD550PDXN7	Posteriore destro	25	500 / 600
FMDD550PSXN7	Posteriore sinistro		
FMDD650PDXN7	Posteriore destro	25	600 / 700
FMDD650PSXN7	Posteriore sinistro		

ACCESSORI & RICAMBI	
CODICE	ARTICOLO
HACHFORMAS00	Innesto forgiato maschio
HACHFORFEM00	Innesto forgiato femmina

TERMINALI - zincati



CODICE	ARTICOLO	H
FOBC500RIBZO	Laterale	500
FOBC506RIBZO	Posteriore	600
FOBC600RIBZO	Laterale	600
FOBC607RIBZO	Posteriore	700

TABELLA

MOD. H	A	B	C	D
500 / 600	500	600	478	578
600 / 700	600	700	578	678

Legenda:
H = Altezza (mm)

MOD. H = Modello - Altezza (mm)
A/B/C/D = (mm)

POSTERIORE

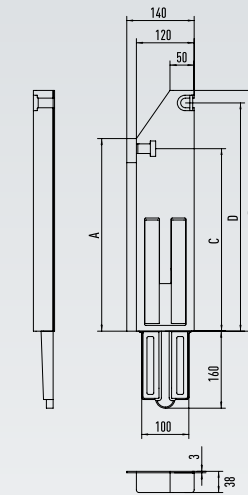

POSTERIORE DRITTO

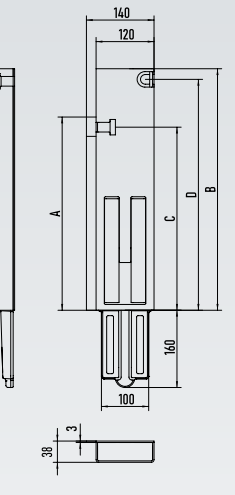

LATERALE / POSTERIORE

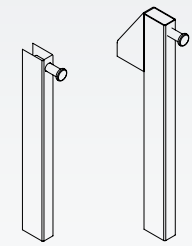

Innesto forgiato
maschio

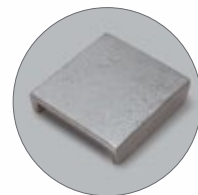

Innesto forgiato
femmina

MONTANTI

RIBALTABILI TASCA A CUNEO TR5 DOPPIA ALTEZZA



RIBALTABILI TASCA A CUNEO TR5 DOPPIA ALTEZZA - cataforesi			
CODICE	ARTICOLO	SPESSORE SPONDA (mm)	H
FMOA450PDXN7	Posteriore destro	30	400 / 500
FMOA450PSXN7	Posteriore sinistro		
FMOA560PDXN7	Posteriore destro		500 / 600
FMOA560PSXN7	Posteriore sinistro		
FMOA650PDXN7	Posteriore destro	600 / 700	
FMOA650PSXN7	Posteriore sinistro		

RIBALTABILI TASCA A CUNEO TR5 DOPPIA ALTEZZA DRITTO - cataforesi			
CODICE	ARTICOLO	SPESSORE SPONDA (mm)	H
FMNA450PDXN7	Posteriore destro	30	400 / 500
FMNA450PSXN7	Posteriore sinistro		
FMNA550PDXN7	Posteriore destro		500 / 600
FMNA550PSXN7	Posteriore sinistro		
FMNA650PDXN7	Posteriore destro	600 / 700	
FMNA650PSXN7	Posteriore sinistro		

ACCESSORI & RICAMBI	
CODICE	ARTICOLO
HACFPERTR5Z0	Perno zincato TR5
HACHFORMAS00	Innesto forgiato maschio
HACHFORFE100	Innesto forgiato femmina TR5

TERMINALI - zincati



CODICE	ARTICOLO	H
FOCMTR5400Z0	Laterale	400
FOCMTR5500Z0	Laterale	500
FOCMTR5600Z0	Laterale	600
FOBTR78PDXZ0	Posteriore dx	800
FOBTR78PSXZ0	Posteriore sx	800

TABELLA

MOD. H	A	B	C	D
400 / 500	400	500	378	478
500 / 600	500	600	478	578
600 / 700	600	700	578	678

Legenda:
H = Altezza (mm)

MOD. H = Modello - Altezza (mm)
A/B/C/D = (mm)

POSTERIORE

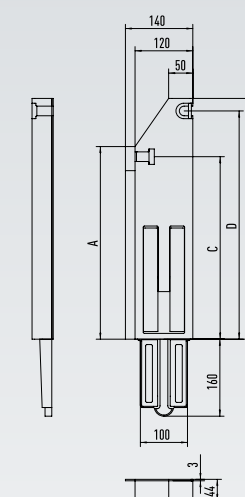

POSTERIORE DRITTO

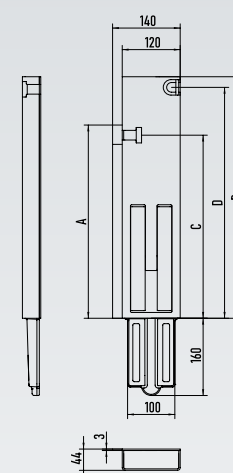

LATERALE



POSTERIORE

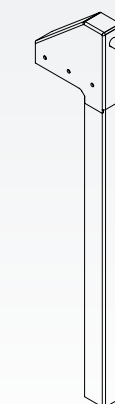

Perno zincato TR5

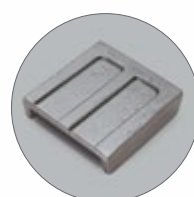
Innesto forgiato
maschioInnesto forgiato
femmina TR5

MONTANTI

RIBALTABILI TASCA A CUNEO TR5 1 LEVA



RIBALTABILI TASCA A CUNEO TR5 1 LEVA - cataforesi			
CODICE	ARTICOLO	SPESSORE SPONDA (mm)	H
FMOB400PDXN7	Posteriore destro 1 leva	30	400
FMOB400PSXN7	Posteriore sinistro 1 leva		
FMOB500PDXN7	Posteriore destro 1 leva		500
FMOB500PSXN7	Posteriore sinistro 1 leva		
FMOB600PDXN7	Posteriore destro 1 leva		600
FMOB600PSXN7	Posteriore sinistro 1 leva		
FMOB700PDXN7	Posteriore destro 1 leva		700
FMOB700PSXN7	Posteriore sinistro 1 leva		
FMOB800PDXN7	Posteriore destro 1 leva		800
FMOB800PSXN7	Posteriore sinistro 1 leva		

ACCESSORI & RICAMBI	
CODICE	ARTICOLO
HACFPERTR5Z0	Perno zincato TR5
HACHFORMAS00	Innesto forgiato maschio
HACHFORFE100	Innesto forgiato femmina TR5

TERMINALI - zincati



CODICE	ARTICOLO	H
FOCMTR5400Z0	Laterale / Posteriore	400
FOCMTR5500Z0	Laterale / Posteriore	500
FOCMTR5600Z0	Laterale / Posteriore	600
FOCMTR5700Z0	Laterale / Posteriore	700
FOCMTR5800Z0	Laterale / Posteriore	800

TABELLA

MOD. H	A	B
400	400	378
500	500	478
600	600	578
700	700	678
800	800	778

Legenda:
H = Altezza (mm)

MOD. H = Modello - Altezza (mm)
A/B = (mm)

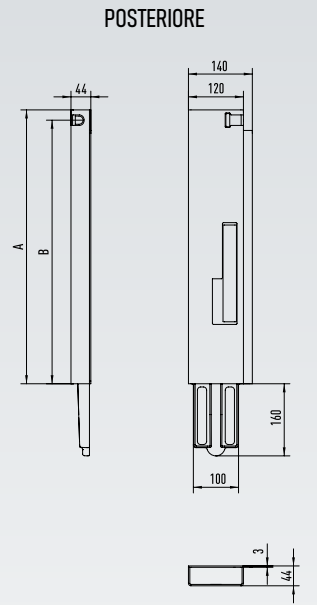

LATERALE / POSTERIORE



Perno zincato TR5

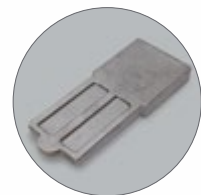

Innesto forgiato maschio

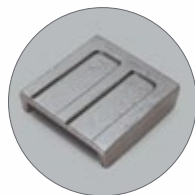

Innesto forgiato femmina TR5

MONTANTI

RIBALTABILI 1740 TASCA
A CUNEO

RIBALTABILI 1740 TASCA A CUNEO - cataforesi			
CODICE	ARTICOLO	SPESSORE SPONDA (mm)	H
FMDA174AD1N7	Anteriore dx_Largo 80	25	400/1740
FMDA174AS1N7	Anteriore sx_Largo 80		400/1740

TERMINALI - zincati



CODICE	ARTICOLO	H
FOBC400RIBZO	Laterale / Posteriore	400

Legenda:
H = Altezza (mm)

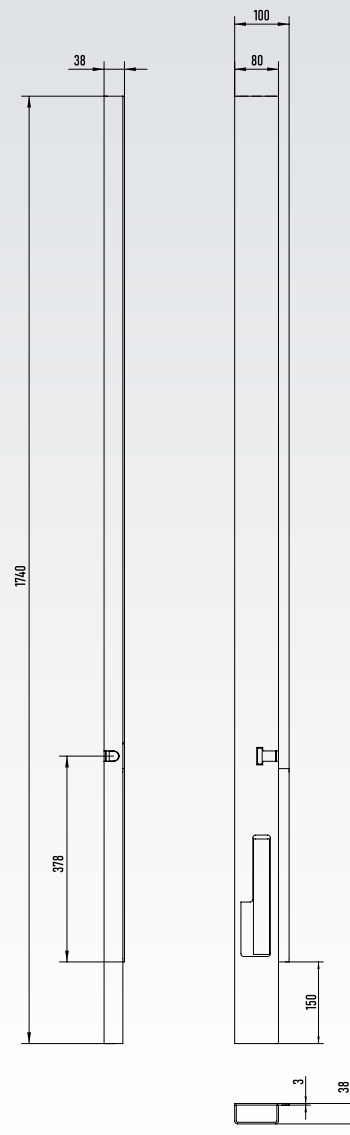

LATERALE / POSTERIORE



MONTANTI

RIBALTABILI 1740 TASCA
A CUNEO TR5

RIBALTABILI 1740 TASCA A CUNEO TR5 - cataforesi			
CODICE	ARTICOLO	SPESSORE SPONDA (mm)	H
FMOA174AD1N7	Anteriore dx_Largo 80	30	400/1740
FMOA174AS1N7	Anteriore sx_Largo 80		400/1740

ACCESSORI & RICAMBI

CODICE	ARTICOLO
HACFPERTR5ZO	Perno zincato TR5

TERMINALI - zincati



CODICE	ARTICOLO	H
FOCMTR5400ZO	Laterale / Posteriore	400

Legenda:
H = Altezza (mm)



LATERALE / POSTERIORE



Perno zincato TR5

MONTANTI

RIBALTABILI TASCA A CUNEO SPESSORE 45



RIBALTABILI TASCA A CUNEO SPESSORE 45 - cataforesi			
CODICE	ARTICOLO	SPESSORE SPONDA (mm)	H
FMPA400ADNX7	Anteriore dx_Largo 80	40	400
FMPA400ASXN7	Anteriore sx_Largo 80		
FMPA400CENN7	Centrale	40	500
FMPA400PDXN7	Posteriore destro		
FMPA400PSXN7	Posteriore sinistro	40	600
FMPA500ADNX7	Anteriore dx_Largo 80		
FMPA500ASXN7	Anteriore sx_Largo 80	40	800
FMPA500CENN7	Centrale		
FMPA500PDXN7	Posteriore destro	40	800
FMPA500PSXN7	Posteriore sinistro		
FMPA600ADNX7	Anteriore dx_Largo 80	40	800
FMPA600ASXN7	Anteriore sx_Largo 80		
FMPA600CENN7	Centrale	40	800
FMPA600PDXN7	Posteriore destro		
FMPA600PSXN7	Posteriore sinistro	40	800
FMPA800ADNX7	Anteriore dx_Largo 80		
FMPA800ASXN7	Anteriore sx_Largo 80	40	800
FMPA800CENN7	Centrale		
FMPA800PDXN7	Posteriore destro	40	800
FMPA800PSXN7	Posteriore sinistro		

ACCESSORI & RICAMBI	
CODICE	ARTICOLO
HACFPERSP450	Perno grezzo SP45
HACHFORMAS00	Innesto forgiato maschio
HACHFORFE100	Innesto forgiato femmina TR5

TABELLA		
MOD. H	A	B
400	400	378
500	500	478
600	600	578
800	800	778

Legenda:
H = Altezza (mm)

MOD. H = Modello - Altezza (mm)
A/B = (mm)

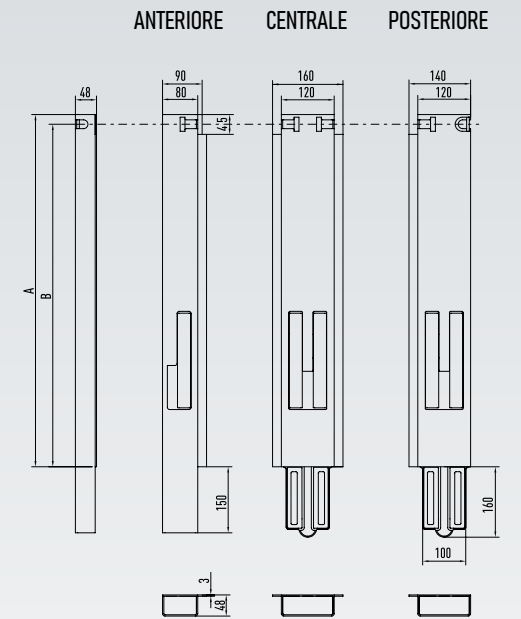

Perno grezzo SP45



Innesto forgiato maschio

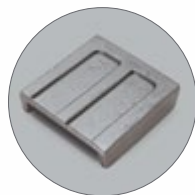

Innesto forgiato femmina TR5

MONTANTI

SOPRAMONTANTI RIBALTABILI



SOPRAMONTANTI RIBALTABILI - cataforesi			
CODICE	ARTICOLO	SPESSORE SPONDA (mm)	H
FMJA400ADXN7	Anteriore dx_Largo 80	25	400
FMJA400ASXN7	Anteriore sx_Largo 80		
FMJA400CENN7	Centrale		
FMJA400PDXN7	Posteriore destro	25	500
FMJA400PSXN7	Posteriore sinistro		
FMJA500ADXN7	Anteriore dx_Largo 80		
FMJA500ASXN7	Anteriore sx_Largo 80	25	600
FMJA500CENN7	Centrale		
FMJA500PDXN7	Posteriore destro		
FMJA500PSXN7	Posteriore sinistro	25	700
FMJA600ADXN7	Anteriore dx_Largo 80		
FMJA600ASXN7	Anteriore sx_Largo 80		
FMJA600CENN7	Centrale	25	800
FMJA600PDXN7	Posteriore destro		
FMJA600PSXN7	Posteriore sinistro		
FMJA700ADXN7	Anteriore dx_Largo 80	25	400
FMJA700ASXN7	Anteriore sx_Largo 80		
FMJA700CENN7	Centrale		
FMJA700PDXN7	Posteriore destro	25	500
FMJA700PSXN7	Posteriore sinistro		
FMJA800ADXN7	Anteriore dx_Largo 80		
FMJA800ASXN7	Anteriore sx_Largo 80	25	600
FMJA800CENN7	Centrale		
FMJA800PDXN7	Posteriore destro		
FMJA800PSXN7	Posteriore sinistro	25	700
FMJA800CENN7	Centrale		
FMJA800PDXN7	Posteriore destro		
FMJA800PSXN7	Posteriore sinistro	25	800
FMJA800CENN7	Centrale		
FMJA800PDXN7	Posteriore destro		
FMJA800PSXN7	Posteriore sinistro	25	800
FMJA800CENN7	Centrale		
FMJA800PDXN7	Posteriore destro		
FMJA800PSXN7	Posteriore sinistro	25	800
FMJA800CENN7	Centrale		
FMJA800PDXN7	Posteriore destro		

TERMINALI - zincati



CODICE	ARTICOLO	H
FOBC400RIBZO	Laterale / Posteriore	400
FOBC500RIBZO	Laterale / Posteriore	500
FOBC600RIBZO	Laterale / Posteriore	600
FOBC700RIBZO	Laterale / Posteriore	700
FOBC800RIBZO	Laterale / Posteriore	800

TABELLA

MOD. H	A	B
400	400	378
500	500	478
600	600	578
700	700	678
800	800	778

Legenda:
H = Altezza (mm)

MOD. H = Modello - Altezza (mm)
A/B = (mm)

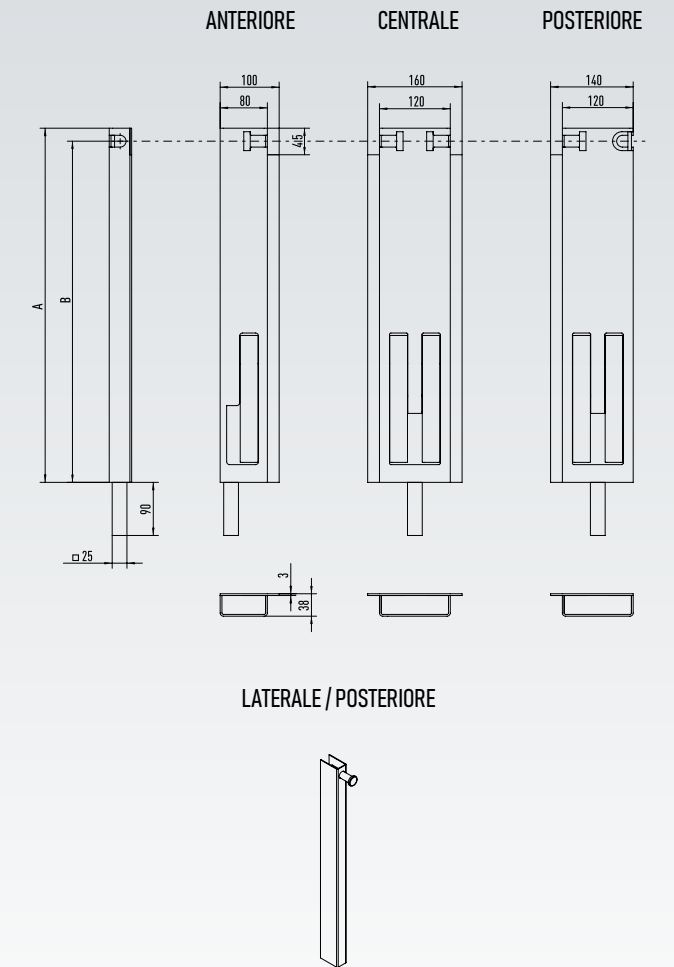

MONTANTI

SOPRAMONTANTI RIBALTABILI TRILATERALI



SOPRAMONTANTI RIBALTABILI TRILATERALI - cataforesi			
CODICE	ARTICOLO	SPESSORE SPONDA (mm)	H
FMKA400ADXN7	Anteriore dx_Largo 80	25	400
FMKA400ASXN7	Anteriore sx_Largo 80		
FMKA400CENN7	Centrale		
FMKA400PDXN7	Posteriore destro	25	500
FMKA400PSXN7	Posteriore sinistro		
FMKA500ADXN7	Anteriore dx_Largo 80		
FMKA500ASXN7	Anteriore sx_Largo 80	25	600
FMKA500CENN7	Centrale		
FMKA500PDXN7	Posteriore destro		
FMKA500PSXN7	Posteriore sinistro	25	700
FMKA600ADXN7	Anteriore dx_Largo 80		
FMKA600ASXN7	Anteriore sx_Largo 80		
FMKA600CENN7	Centrale	25	800
FMKA600PDXN7	Posteriore destro		
FMKA600PSXN7	Posteriore sinistro		
FMKA700ADXN7	Anteriore dx_Largo 80	25	400
FMKA700ASXN7	Anteriore sx_Largo 80		
FMKA700CENN7	Centrale		
FMKA700PDXN7	Posteriore destro	25	500
FMKA700PSXN7	Posteriore sinistro		
FMKA800ADXN7	Anteriore dx_Largo 80		
FMKA800ASXN7	Anteriore sx_Largo 80	25	600
FMKA800CENN7	Centrale		
FMKA800PDXN7	Posteriore destro		
FMKA800PSXN7	Posteriore sinistro	25	700
FMKA800CENN7	Centrale		
FMKA800PDXN7	Posteriore destro		
FMKA800PSXN7	Posteriore sinistro	25	800
FMKA800CENN7	Centrale		
FMKA800PDXN7	Posteriore destro		
FMKA800PSXN7	Posteriore sinistro	25	900
FMKA800CENN7	Centrale		
FMKA800PDXN7	Posteriore destro		

TERMINALI - zincati



CODICE	ARTICOLO	H
FOEC400TRIZO	Trilaterale	400
FOEC500TRIZO	Trilaterale	500
FOEC600TRIZO	Trilaterale	600
FOEC700TRIZO	Trilaterale	700
FOEC800TRIZO	Trilaterale	800

TABELLA

MOD. H	A	B	C
400	400	356	312
500	500	456	412
600	600	556	512
700	700	656	612
800	800	756	712

Legenda:
H = Altezza (mm)

MOD. H = Modello - Altezza (mm)
A/B/C = (mm)

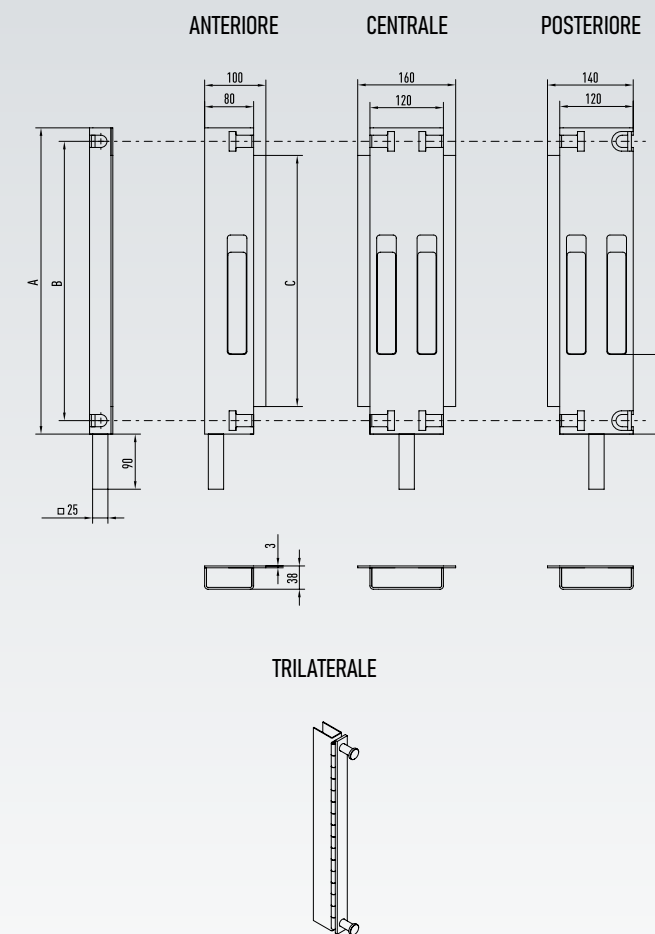

MONTANTI CON SNODO

MONTANTI CON SNODO - cataforesi

CODICE	ARTICOLO	SPESSORE SPONDA (mm)	H
FMFC600CENN7	Centrale	25	600
FMFC800CENN7	Centrale		800
FMFCA00CENN7	Centrale		1000

ACCESSORI & RICAMBI

CODICE	ARTICOLO
FCSMTASSAL00	Tasca grezza a saldare
FCPMTASLATZ0	Tasca zincata laterale
FCPMTASRLAZ0	Tasca zincata regolabile laterale completa
FCPMCIASFO00	Ciabatta per montante <i>[compresa]</i>

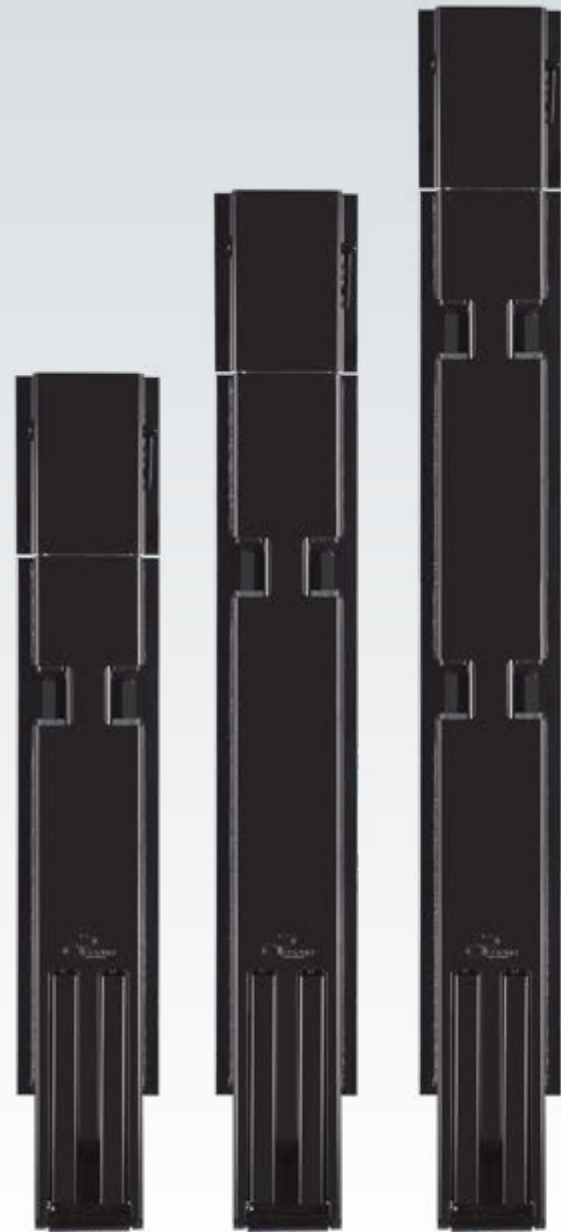

TERMINALI - zincati

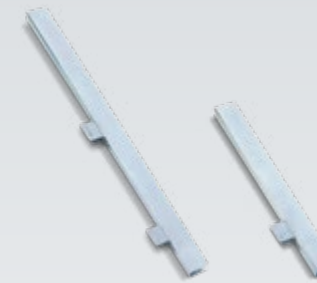

CODICE	ARTICOLO	H
FOAC600LDXZ0	Laterale destro	600
FOAC600LSXZ0	Laterale sinistro	
FOAC800LDXZ0	Laterale destro	800
FOAC800LSXZ0	Laterale sinistro	
FOACA00LDXZ0	Laterale destro	1000
FOACA00LSXZ0	Laterale sinistro	

TABELLA

MOD. H	A	B	C
600	595	-	-
800	732	-	-
1000	595	399	844

Legenda:
H = Altezza (mm)

MOD. H = Modello - Altezza (mm)
A/B/C = (mm)

600 800 1000

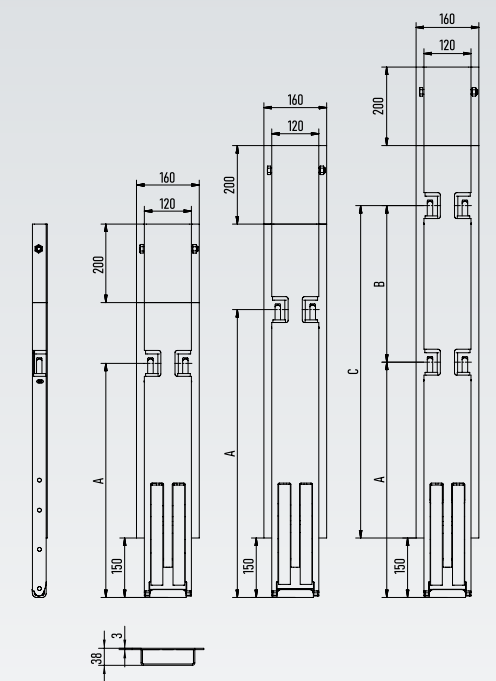

LATERALE

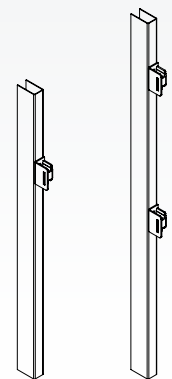

Tasca grezza
a saldare

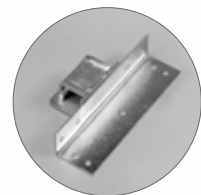

Tasca zincata
laterale

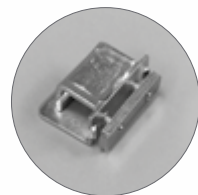

Tasca zincata
regolabile laterale



Ciabatta per montante
[compresa]

MONTANTI

CURTAINSIDER

CURTAINSIDER - grezzo		
CODICE	ARTICOLO	H
FMIA08026000	Curtainsider con battuta_Largo 80	2500

Legenda:
H = Altezza (mm)



MONTANTI

CURTAINSIDER CP4

CURTAINSIDER CP4 - cataforesi		
CODICE	ARTICOLO	H
FMIB000280N7	Curtainsider CP4	2800

ACCESSORI

CODICE	ARTICOLO
FCPMPST150Z0	Porta stecche 150 zincato
FCPMPST600Z0	Porta stecche 600 zincato
FCPMKSF001Z0	Kit sfilo L1060 Curtainsider zincato

RICAMBI

CODICE	ARTICOLO
FCPM45CS0000	Ciabatta Curtainsider
FCPMBSF001ZN	Blocca sfilo Curtainsider zincato
FCPMBSF002ZN	Blocca sfilo Curtainsider con gancio zincato
FCPMGSCS00ZN	Guida sfilo Curtainsider zincato
FCPMSFCS00ZN	Profilo sfilo Curtainsider zincato
HBVFMF3022NM	Molla sfilo grezza

Legenda:
H = Altezza (mm)

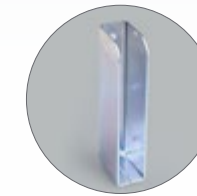
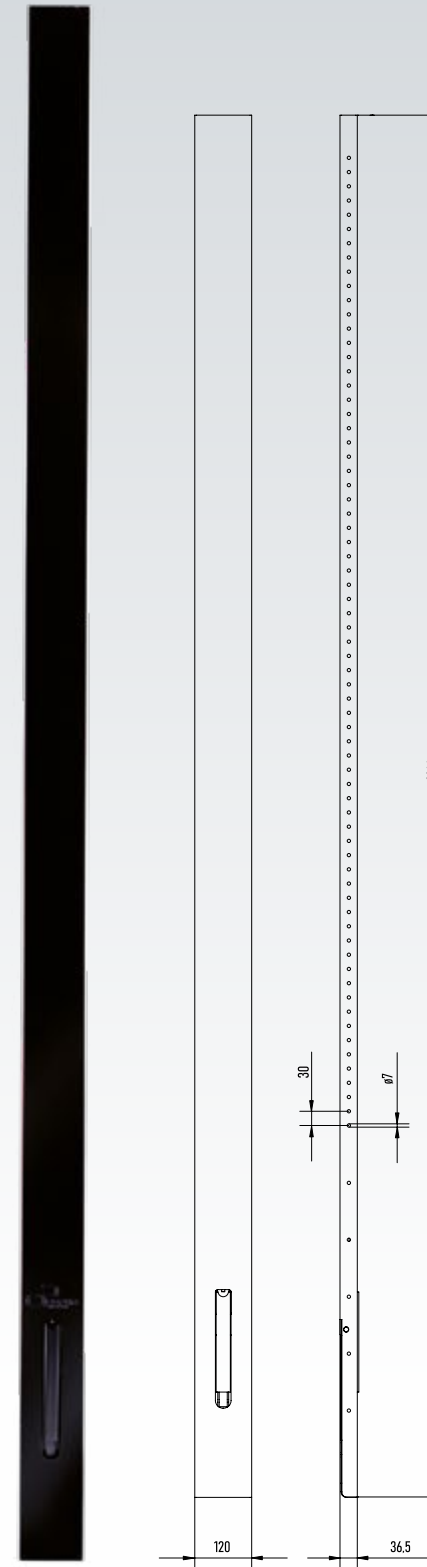

Porta stecche 150
zincato



Porta stecche 600
zincato



Kit sfilo L1060
Curtainsider
zincato



Ciabatta
Curtainsider



Blocca sfilo
Curtainsider zincato



Blocca sfilo
Curtainsider
con gancio zincato

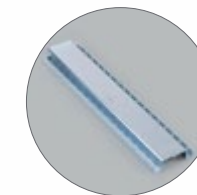

Guida sfilo
Curtainsider
zincato



Profilo sfilo
Curtainsider zincato



Molla sfilo grezza

MONTANTI

CURTAINSIDER CP5 600 / 800 / 1000

CURTAINSIDER CP5 - cataforesi

CODICE	ARTICOLO	H
FMIB600280N7	Curtainsider CP5 600	2800
FMIB800280N7	Curtainsider CP5 800	2800
FMIBA00280N7	Curtainsider CP5 1000	2800

ACCESSORI

CODICE	ARTICOLO
FCPMPST150Z0	Porta stecche 150 zincato
FCPMKSF001Z0	Kit sfilo L1060 Curtainsider zincato

RICAMBI

CODICE	ARTICOLO
FCPM45CS0000	Ciabatta Curtainsider
FCPMBSF001ZN	Blocca sfilo Curtainsider zincato
FCPMBSF002ZN	Blocca sfilo Curtainsider con gancio zincato
FCPMGSCS00ZN	Guida sfilo Curtainsider zincato
FCPMSFCS00ZN	Profilo sfilo Curtainsider zincato
HBVFMF3022NM	Molla sfilo grezza

TERMINALI - zincati

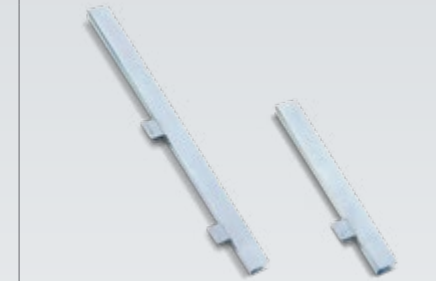

CODICE	ARTICOLO	H
FOAC60ALDXZO	Laterale destro	600
FOAC60ALSXZO	Laterale sinistro	
FOAC80ALDXZO	Laterale destro	800
FOAC80ALSXZO	Laterale sinistro	
FOACA0ALDXZO	Laterale destro	1000
FOACA0ALSXZO	Laterale sinistro	

Legenda:
H = Altezza (mm)

CP5 600

CP5 800

CP5 1000

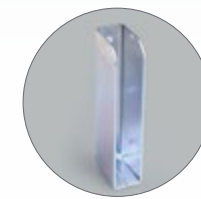
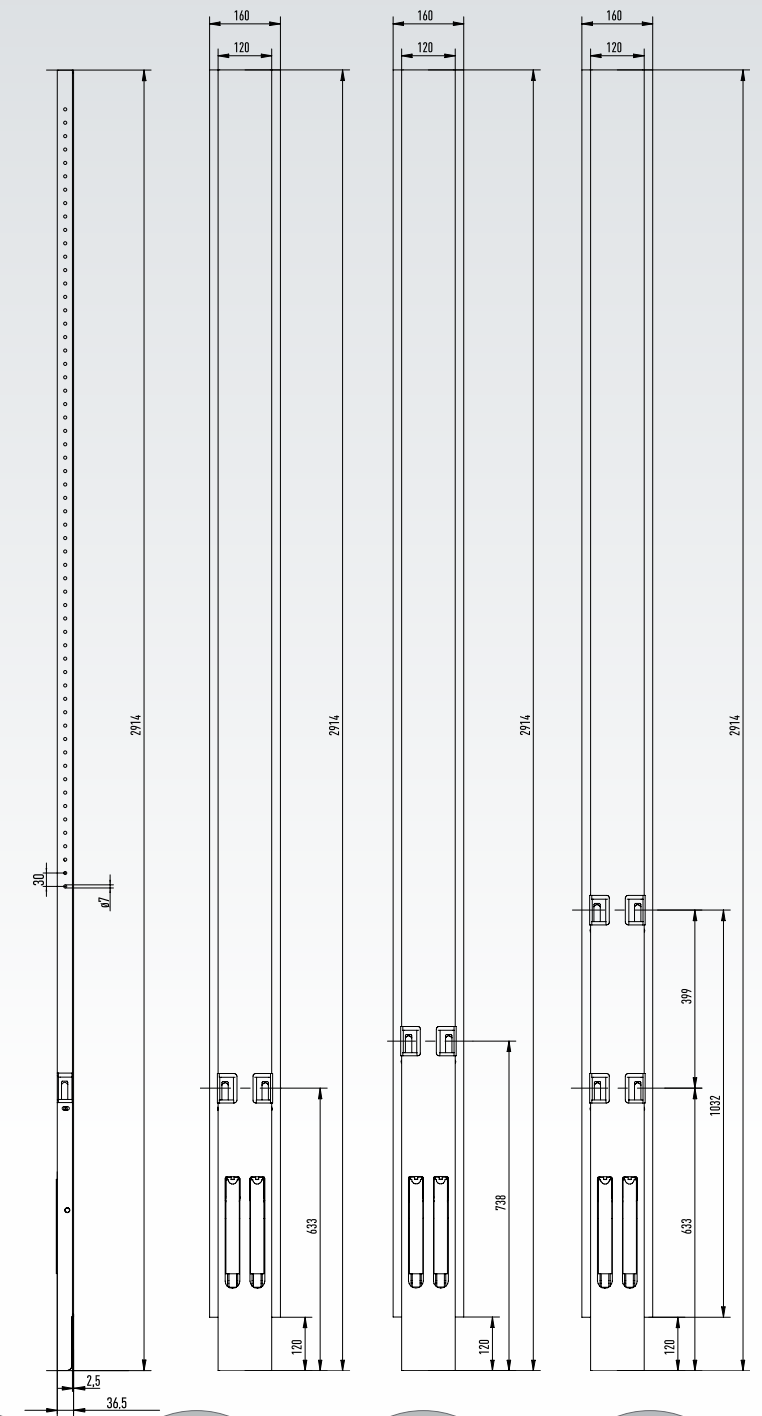

Porta stecche 150
zincato



Kit sfilo L1060
Curtainsider
zincato



Ciabatta
Curtainsider

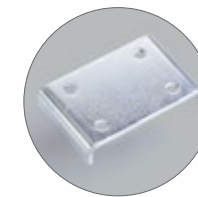

Blocca sfilo
Curtainsider zincato

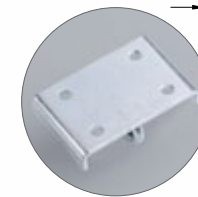

Blocca sfilo
Curtainsider
con gancio zincato

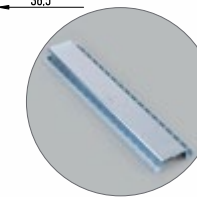

Guida sfilo
Curtainsider
zincato

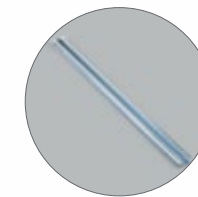

Profilo sfilo
Curtainsider zincato



Molla sfilo grezza

BARRE PARAINCASTRO

PROFILO FERMACARICO



BARRE PARAINCASTRO			
CODICE	MATERIALE	L	S
FAAAZ20180GO		1800	
FAAAZ20190GO		1900	
FAAAZ20200GO		2000	
FAAAZ20210GO	Acciaio zincato + verniciato grigio	2100	2
FAAAZ20220GO		2200	
FAAAZ20230GO		2300	
FAAAZ20240GO		2400	
IQAVTESINNO	Terminale PVC per paraincastro	-	-

BARRE PARAINCASTRO - MODELLO "ALTO"			
CODICE	MATERIALE	L	S
FAEA000230NN	Acciaio verniciato grigio	2300	2
FAEA000240NN		2400	
FAEA000230BO	Acciaio verniciato bianco	2300	2
FAEA000240BO		2400	

BARRE PARAINCASTRO			
CODICE	MATERIALE	L	S
FAAI000180NN	Acciaio INOX "FIORE"	1800	
FAAI000190NN		1900	
FAAI000200NN		2000	
FAAI000210NN		2100	2
FAAI000220NN		2200	
FAAI000230NN		2300	
FAAI000240NN		2400	
IQAVTESINNO	Terminale PVC per paraincastro	-	-

BARRE PARAINCASTRO - MODELLO "ALTO"			
CODICE	MATERIALE	L	S
FAEI000230NN	Acciaio INOX "FIORE"	2300	2
FAEI000240NN		2400	

Legenda:
L = Lunghezza (mm)
S = Spessore (mm)



Terminale PVC

NOTA: PARAINCASTRO A DISEGNO SONO DISPONIBILI SU RICHIESTA

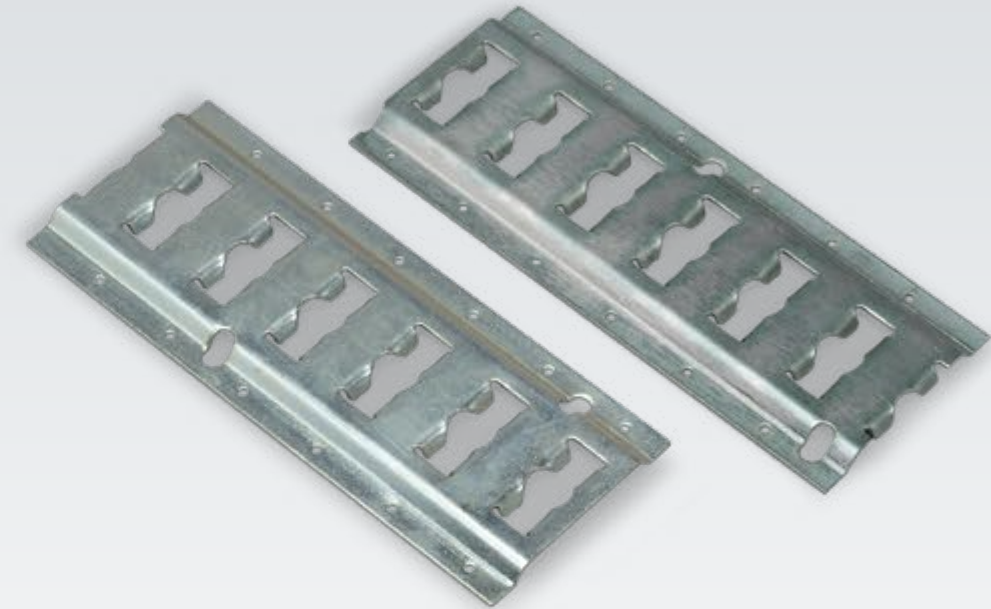

PROFILO FERMACARICO			
CODICE	MATERIALE	L x L1 x S	PESO kg
FGAABARFMCZO	Acciaio zincato bianco	3060 x 134 x 2,2	6,3

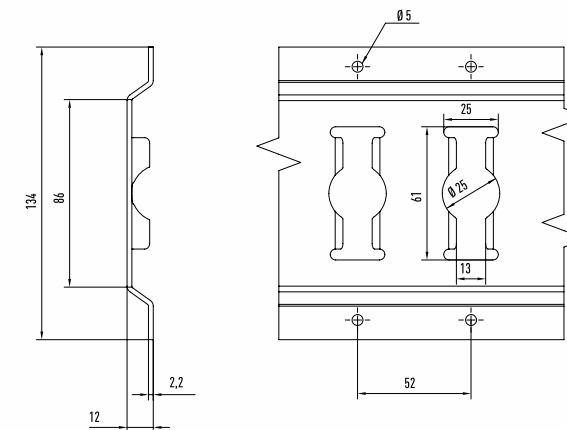

ACCESSORIO



CODICE	ARTICOLO	H	P
HACPTERFCANO	Terminale plastica	134	12

Legenda:
L = Lunghezza (mm)
L1 = Larghezza (mm)
P = Profondità (mm)
H = Altezza (mm)
S = Spessore (mm)

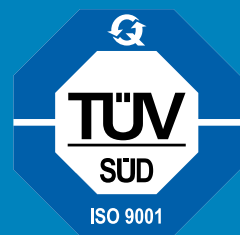

© COPYRIGHT 2025 CO.PAR. S.R.L.
CO.PAR. SI RISERVA IL DIRITTO DI MODIFICARE MODELLI E MISURE SENZA PREAVVISO

PROGETTO & STUDIO GRAFICO: MONICAALBERTON.COM
FOTO: STUDIO PRIMOPIANO E LUCIOLINGUANOTTO.COM
STAMPA: MARIGRAF S.R.L.

STAMPATO IN GIUGNO 2025



ITALIANO

PLASTIC DIVISION

Via Tiepolo, 4
35019 Tombolo (PD), Italy

METAL DIVISION

Via Casoni Nuova, 12
35014 Fontaniva (PD), Italy

Tel. +39 049 9445040

Fax +39 049 9449014

info@copar.it

www.copar.it



MADE IN ITALY

